

① See Str 25 FEB 1992 Betty Margaret Hall DROM

I. Henry Jacob H of the family, II/ Burnell H SC-mother line

A; Marie Louise H

↳ Mose H line

1. Arthur Duane Hall

2. Melba Ann Hall b 12 OCT 1942 (Bedias, TX)

md 29 AUG 1961 (Clute, TX) Jerry Ben Nargrane b 25 JUN 1939 (Sulphur Springs, TX)

a. Marie Annette Nargrane "REE" b 4 AUG 1902

(Freeport, TX) md 4 DEC 1982 (B. Quitman, TX)

Craig Stephens Clanton b 24 SEP 1960 (B. Quitman, TX)

1. Joshua Aaron Clanton b 11 FEB 1989  
(Sulphur Springs, TX)

11. Stephanie Marie Clanton b 7 JUL 1990  
(Sulphur Springs, TX)

b. Tracy Ann Nargrane b 1 APR 1966 (Garland, TX)

md 1st 1986 (B. Quitman, TX) Phillip Wayne Grimes  
b 19 MAR 1966 DIV

md 2nd 31 DEC 1990 (Chapel Hill, TX) Kelly Jean  
Acker b 3 MAR 1967 (Tyler, TX)

3. Raymond Leo Hall b 17 NOV 1944 (Houston, TX)

4. Betty Margaret Hall b 28 NOV 1945 (West Columbia, TX)

md 16 DEC 1967 (Petersburg, TX) Carl Richard Battles

b 12 JAN 1940 (A. Mear, OH) [ERS md 1st Margie Lee Urban

a. Cynthia Ann Battles b 18 AUG 1966 (Houston, TX)

b. Richard Andrew Battles b 7 JUN 1968 (Houston, TX)

c. James Alan Battles b 15 JUN 1972 (Houston, TX)

② 14 APR 1996

BMH attended the Lynchurch Federal in Tom Hall, TX  
on 14 APR 1996

③ 27 APR 1996 - Called Betty Battles [(713) 729-1777] to ask for identification of some who attended the lecture on 14 APR 1996. Learned the following:

- #1 = Arthur Duane Hall = Betty's brother
- #13 = Raymond H. U = son of Henry Forsh U  
(#13 is his "friend" - not his wife)
- #16 = N.J. Jones, Jr - Betty does not know
- #17 = Patti (Upchurch) CARONA = dau of Charles Henry U + gd of Henry Forsh U.

over the phone Betty comes across as very upbeat and cheerful. Earlier in the day I talked to her mother in an effort to reach Betty. She said Betty was helping her husband with inventory.

④ TEXAS BIRTH INDEX - PER C. J. PETERSON, JR 18 JUL 2005  
1903 - 1999

| Name                | Birth Date  | Gender | Birth County | Father's Name      | Mother's Name         |
|---------------------|-------------|--------|--------------|--------------------|-----------------------|
| Author Duane Hall   | 15 Sep 1937 | Male   | Grimes       | Eldred A Hall      | Mara L Upchurch       |
| Betty Margaret Hall | 28 Nov 1945 | Female | Brazoria     | Eldred Arthur Hall | Marie Louise Upchurch |

{ CORRECT = MARIE LOUISE U } ← ← ← ✓



It was great to meet you and Maue and the other family members. As you can imagine we have returned with many impressions and with much information. I want to thank you again for your help in making the Tomhall meeting a success. It was great. We are also substantially indebted to Lessie and her family.

I hope we can use this trip as a springboard to better document our extended family. Enclosed is a list of answers needed for your mother's family. I will be grateful for any answers you or she have or can get. We never have everything - but I like to try.

Enclosed are some extra Upchurch Bulletins flyers. I would appreciate it if you would spread them about.

Thank you again for your cooperation.



Sincerely yours  
Phil Upchurch

P.S. A copy of the list of those participating at Bednar is also enclosed.

Phil U -

[ROBERT PHILLIP UPCHURCH]

P.S. copy of matter outline for Henry Harold is enclosed. Phil U

MISSING DETAILS ON THE FAMILY  
OF MARIE LOUISE (LUPENURCH) HALL

30 APR  
1996

- 1) For Marie Louise  
a) Did she have just four children?  
b) where is Eldred Arthur Hall buried?
- 2) For Arthur Duane Hall  
a) when in 1963, 1976 and 1979 did he marry?  
b) where in Germany did he marry?  
c) where were his 2nd and 3rd marriages?  
d) where is Kathryn Elizabeth Deuler buried?  
e) where was Tessamae Jennette Torres born?  
f) Did he have just three children?  
g) Did any of his children marry/have children? If so, details?
- 3) For Melba Ann Hall  
a) Did she have just two children?  
b) Did Marie Annette Nargwane have just two children?  
c) For Tracy Ann Nargwane  
i) when in 1986 did she marry?  
ii) where was Phillip Wayne Tucker born?  
iii) Did she have any children? If so, details?
- 4) For Raymond Leo Hall  
a) Did he marry/have children? If so, details?
- 5) For Betty Margaret Hall  
a) Did you have just two children?  
b) Did any of your children marry/have children?  
If so, details?
- 6) P.S. - Is the Geraldine who came with Duane the same as Freddie Marie Magrogan - or is she a new person on the scene.



BETTY MARGARET HALL

XFN-29648

REC'D  
10 APR 1993

[BETTY BATTLES  
12415 MOLLINS ST  
HOUSTON, TX 77035]

1993

Upchurch Family Reunion

July 25, 1993 - Sunday

Bedias, Texas

(Leslie & Mack said you might  
come. Would love to meet you.)  
Will send reminder July 1. Wanted  
to give you time to plan.

Rec'd in ltr 25 OCT 1993 Jesse Seana Lee & RPH  
Card sent out by Betty Battles (BMTA). Phone No = 713-729-1777

Upchurch Reunion

July 26, 1992

Civic Center #2

Bedias, Texas

/ rec'd  
originally  
by M/M  
Mack &  
of  
Tomball,  
TX

(4<sup>th</sup> Sun. in July)



BETTY MARGARET HALL

XID-29648

MICHAEL ENTERPRISES

P. O. BOX 35804

TUCSON, ARIZONA 85740

17 APR 1993

BETTY BATTLES

12415 MULLINS ST.

HOUSTON, TX 77035

Dear Cousin Betty,

Thank you for your post card alerting me to the reunion scheduled for 25 JUL 1993. I would love to come but the pressure of my work in the University will keep me in Arizona. Sometime in the not too distant future I will be retired and more free to attend such events. I have long planned to give an Upchurch lecture in Houston and will get to it in due course.

We continue to make excellent progress on the Master outline for the James W. <sup>(IV)</sup> Burrill Upchurch Subdon. Quite a few people continue to correspond and to send in details. Still, there



is always more to do.

The reunion should be an excellent place to feel-out people about their interest in our Upchurch history and to learn of their willingness to get or supply details. If you get the names and addresses of any interested parties I'd be glad to write to them.

If you think a handout sheet on the Upchurch Bulletin would be useful at the reunion let me know and I will send a dozen or so sets or whatever number might be desired. Also please let me know if a copy of our updated master outline would be handy. I think you have a copy.

Do enjoy the gathering in Geddes. There are always happy occasions.

☺  
Sincerely yours  
Phil Upchurch  
[ROBERT PHILIP UPCHURCH]

16 JUL 1992

BETTY HALL BATTLES  
12415 MULLINS  
HOUSTON, TX 77035

Dear Cousin Betty,

The details in your letter of 11 JUL 1992 have now been transferred to the master outline and to the Biopics of the various individuals involved and I want to thank you for your valuable contribution. Please let me know anytime you want an updated copy of the master outline for your part of the family.

Enclosed is a list of questions on Riley Johnson and his children. I assume you have the set I sent earlier on Henry Jacob and his family. Perhaps you will be able to make some progress on these when your family group meets. Enclosed are some sets of details on the U B. If anyone in your family group meeting has an interest in the U B I would be happy to hear from them. Of course I hope you will strengthen your ties with various family members who might help me update the master outline.

Provided herewith is a copy of my 11"X17" master outline sheet for the first six generations of Upchurch in America with your line and mine highlighted. Gilbert U (XFD-82) was my GGF.

Betty, I am sure there is much more we can share with each other. Getting the master outline more completed is always a challenge that is before us. Over the last 10-12 years we have made great progress on the James U, IV / Burwell U Subdon to which you belong. A lot of people have helped and continue to help. It is a great satisfaction to see the progress we have made.

Hope to hear from you soon.

☺ Sincerely yours  
Phil Upchurch

[ROBERT PHILIP UPCHURCH]

MISSING DETAILS ON TRILEY 15 JUL 92  
JUDSON WPCURCH & HIS CHILDREN

- 1) For Riley Judson U & his wives.
  - a) Did he marry first 13 MAR 1879 or 15 MAR 1879?
  - b) where did Mary Pura Sanders die?
  - c) where did he marry the second time?
  - d) what does the "S" in Mary S. U stand for?
  - e) Did he have just 12 children by his first wife?
- 2) For Elsie Alma U
  - a) when did she marry?
  - b) where did she marry?
  - c) Did David Daniel Pritchett die 7 AUG 1957 or 16 AUG 1957?
  - d) Did she have just five children? (including Gertrude)
- 3) For Lowell Brent U
  - a) For real name Is it Lowell Brent U or LOYL BRENTLY U. (see attached Biogill).
  - b) when & where did he marry?
  - c) For Esther Bell Miller
    - i) when in 1894 was she born?
    - ii) when in 1978 did she die?
    - iii) where did she die?
- 4) For Jenny Nevada U
  - a) where in TX was she born?
  - b) where is she buried?
  - c) when and where did she marry?
  - d) Did she have just two children?
  - e) For Charles Frank Isbell
    - i) when was he born?
    - ii) where was he born?
    - iii) where is he buried?

5) For John Raymond U

- a) when and where did he marry?
- b) Did he have just two children?
- c) For his wife
  - i) what is her full maiden name?
  - ii) when and where was she born?
  - iii) when and where did she die?
  - iv) where is she buried?

6) For Nancy Jane U

- a) Did she die 4 OCT 1963 or 13 OCT 1963
- b) Did she have just four children?
- c) where was Walter Sherwood Brown born?

7) For Agnes U

- a) what is her full maiden name?
- b) where in TX was she born?
- c) where is she buried?
- d) Did she have just one child?
- e) when and where did she marry the second time?

f) For Tom Brown

- i) what is his full name?
- ii) when and where was he born?
- iii) when and where did he die?
- iv) where is he buried?

g) For Her Second Husband (- - - Shell)

- i) what was his full name?
- ii) when and where was he born?
- iii) when and where did he die?
- iv) where is he buried?

8) For Marcus Mayfield U

- a) where in TX was he born?
- b) when and where did he marry?
- c) For Pearl A. Dudley - what does "A" stand for, when, in 1899 born, where born, when in 1981 died, where died?

9) For Henry Jacob U

a) where in TX was he born?

b) Did he have just five children?

10) For Martha U

a) what was her full maiden name?

b) where in TX was she born?

c) Did she die 1 DEC 1963 or 30 NOV 1963?

d) when and where did she marry?

e) Did she have just two children?

f) For George Emitt Wooster.

i) when in 1881 was he born?

ii) where was he born?

11) For Mary U

a) what was her full maiden name?

b) where in TX was she born?

c) when and where was she married?

d) For Ted Mobley

i) what was his full name?

ii) when & where was he born?

iii) when and where did he die?

iv) where is he buried?

12) For Edna N MN U

a) was she born 15 MAY 1897 or 14 MAY 1897?

13) For Judson Weldon U

a) where in TX was he born?

b) where did he die?



BETTY MARGARET HALL  
MICHAEL ENTERPRISES  
P. O. BOX 35804  
TUCSON, ARIZONA 85740

XID-29648

13 JUL 1992

5:00 AM

BETTY BATTLES  
12415 MULLINS ST  
HOUSTON, TX 77035

Dear Cousin Betty

Your letter of 11 JUL 1992 is at hand.  
Sorry I left out the details on the  
Upchurchs Bulletin. Descriptive information  
is enclosed. Will be happy to have your  
order.

I'll mail your letter as soon as  
possible. Have just returned from a  
three day out-of-town trip.

☺ Sincerely yours  
Phil Upchurch

[ROBERT PHILIP UPCHURCH]

BETTY MARGARET HALL

XID-29648

MICHAEL ENTERPRISES

P. O. BOX 35804  
TUCSON, ARIZONA 85740

19 MAR 1992

BETTY HALL BATTLES

12415 MULLINS

HOUSTON, TX 77035

Dear Cousin Betty,

I am most pleased to have your letter of 25 FEB 1992 and have spent my spare time in the last week or so integrating your records with mine. You presented a lot of detail I did not have, especially on the descendants of Henry Jacob U.

Enclosed are details on the Upchurch Bulletin. I would be happy to have you as a subscriber and perhaps you might like to get back issues also.

Enclosed are two sets of questions. I will be grateful for any answers you have or can get.

Also enclosed is a copy of my master outline for Moses U (XID-2030), his children and grandchildren. If I have descendants of his grandchildren a number on the left hand side of the sheet shows the continuation section containing added details. I am enclosing continuation sections 21 (A-E) which is on your ancestor Henry Jacob U.

2.

It is obvious that you are seriously interested in your Upchurch heritage. I hope we can continue our correspondence and share aspects of mutual interest. It would facilitate our interaction if you had access to all the copies of the Upchurch Bulletin or so much of my data is recorded there. However, we can continue to help each other even if you do not have the U.B.

You belong to the James U, IV clan and you are descended from his only known child Barnell U. This forms the James U, IV / Barnell U subclan about which I have written much in the U.B. I have quite a few correspondents who have provided input for this subclan and, in fact, continue to do so. We have made fantastic progress on this group but of course have much left to do. I hope you will become a regular supplier of information.

Sincerely yours  
Phil Upchurch

[ROBERT PHILIP UPCHURCH]

QUESTIONS BASED ON LETTER DATED

18 MAR  
1992

25 FEB 1992 FROM BETTY M. (H) BATTLES TO RPH

(EXCLUDING HENRY JACOB UPENURCH SECTION)

1) For Descendants of Oliver Hazard U

a) For your Richard D. U I show William Carmen U "Dick". which of us is correct?

b) For sons of Oliver Hazard U you and I both show sons Moses (Moses Monroe), Arthur (Arthur Barnaby) and Ben (Benjamin S.). Additionally I show Eddie and Walter. Additionally you show Will. This makes 6 sons. Do you have proof of will as distinct from the other five?  
[Now I note I show also a son Jerry U with a ? - RPH - making possibly 7 sons]

2) For Descendants of Riley Judson U [excluding Henry Jacob U sister]

a) Did Elsie Alma U marry David D. PRITCHETT or David D. PRITCHET?

b) I show the first child of Elsie Alma U as Gertrude Ima U b. NOV 1896 (TX) and that the name of this child was later changed to Gertrude Ima U. Is this correct?

c) I. Riley Judson U

A. Martha U and George Emmitt Wooster

1. Morris Wooster and J. T. Pugh

a. Johnny Wooster } do these two correctly  
b. Pat Wooster } bear the last name  
WOOTEN and if so, why?

3) For Martha Paralee U

a) Did she marry Samuel Andrew ISBELL or Samuel Andrew ISBEL?

MISSING DETAILS ON THE FAMILY  
OF HENRY JACOB WPCURCH

16 MAR  
1992

- 1) For Riley Judson W (Father of HWJ)
  - a) was his first marriage 13 MAR 1897 or 15 MAR 1897?
  - b) where did Mary Pina Sanders die?
  - c) where was his second marriage?
  - d) For Mary S. Wpcurch (2nd wife)
    - i) what does the "S." stand for?
    - ii) where in TX was she born?
    - iii) where did she die?
  - e) Did he have just twelve children?
- 2) For Henry Jacob W
  - a) where in TX was he born?
  - b) Did he have just five children?
- 3) For Philip Loyd W
  - a) when and where was his first marriage?
  - b) Did he have only three children?
  - c) For Vera Julia Capps
    - i) where was she born?
    - ii) Did she die 8 AUG 1975 or 8 JAN 1975?
  - d) For Lala Holland
    - i) what was her full maiden name?
    - ii) where was she born?
- 4) For Melba Jean W.
  - a) where is she buried?
  - b) when and where did she marry?
  - c) Did she have just one child?
  - d) Is Edward Francis Daniels, Jr still single?
  - e) For Edward Francis Daniels, Sr
    - i) when and where was he born?
    - ii) when in DEC 1991 did he die?
    - iii) where did he die and where is he buried?

5) For Philip Ray U

- a) when and where did he marry?
- b) Did he have just three children?
- c) For Shirley Scroggins
  - i) what is her full maiden name?
  - ii) where was she born?
- d) where were his three children born?
- e) Are all three of his children still single?

6) For Wanda Faye U

- a) where is she buried?
- b) Did she have just three children?
- c) For Johnny Welch
  - i) what is his full name?
  - ii) where was he born?

d) For Carol Jean Welch

- i) where was she born?
- ii) when and where did she marry?
- iii) Did she have just two children?
- iv) where was Thomas Lynn Shelton born?
- v) where were her two children born?

e) For Johnny Faye Welch

- i) where was he born?
- ii) Is he still single?

f) For Adam Jeff Sharp Welch

- i) where was he born?
- ii) Is he still single?

7) For Marie Louise U

- a) Did she have just four children?
- b) where is Edred Arthur Hall buried?

8) For Raymond Leo Hall

- a) Did he ever marry/have children? If so, details?



9) For Arthur Duane Hall

- How many children did he have?
- When in 1963 did he marry?
- When in 1976 did he marry?
- When in 1979 did he marry?
- Where in Germany did he marry?
- Where did he marry the 2nd & 3rd times?
- Where is Kathryn Elizabeth Decker buried?

h) For Carol Wright

- What is her full maiden name?
- When was she born?

i) For Jeddie Marie Magrogan

- When was he born?

j) Is Duane Eldred Hall still single?

k) Is Sherri Ann Hall still single?

l) For Tessamae Jennette Tower

- When was she born?
- Who are her mother & father?

10) For Melba Ann Hall

a) Did she have just two children?

b) For Marie Annette Hargrave

- Did she have just two children?

c) For Tracy Ann Hargrave

- When in 1986 did she marry?

ii) Did she have any children?

iii) Where was Phillip Wayne Gurner born?

11) For Betty Margaret Hall

a) Did you have just three children?

ii) Are all of your children still single?

12) For Raymond Howard U

a) When & where did he marry?

b) Did he have just two children?

c) Where was Eva Nell Byers born?

4  
13) For Elizabeth Lynette U

- a) Did she have just three children?
- e) when in 1974 did she marry?
- c) where was she ~~born~~ married the 1st & 2nd times?
- d) For Clayton Andrew Toon, Sr
  - i) when was he born?
  - ii) where was he born?
- e) For Keys Bernardine
  - i) what is his full name?
  - ii) where was he born?
- f) where was Clayton Andrew Toon, Jr born?
- g) where was Cinnamon Candice Toon born?
- h) what is the full name of Ronnie - -  
and when and where was he born?

14) <sup>For</sup> Leslie Rayll

- a) where was he born?
- b) Did he marry/ have children?

15) For Bertha Myrtle U

- a) when and where did she marry?
- b) Did she have just three children and just six grand children?
- c) where was Walter Boyzell Phillips born?
- d) For Charles Eddie Phillips
  - i) where was he born?
  - ii) where was Barbara Ann Redd born?
- e) For Belinda Sue Phillips
  - i) where was she born?
  - ii) where did she marry?
  - iii) what is the full name of Mark Hess and where was he born?
  - iv) where were her children born?
  - v) what is the full name of Andrew Hess?

15) For Dorothea Myerle U - continued

f) For Jay Annette Phillips

i) when was she born?

ii) where did she marry?

iii) what is the full name of Edward Gonzalez and where was he born?

iv) when was Triamo Santiago Gonzalez born?

16) For Charles Henry U

a) when and where did he marry the first time?

b) where did he marry the second time?

c) did he have just two children?

d) For Elizabeth Thyra Beasley

i) where was she born?

ii) Is BEASLEY the correct spelling?

e) For Louise (Luten) Brasher

i) what is her full maiden name?

ii) where was she born?

f) For Charles Randall U

i) where was he born?

ii) Is he still single?

g) For Patricia Gail U

i) Is she still single?

BETTY MARGARET HALL

XID-29648

①

REC'D  
3 MAR 1992

February 25, 1992

Robert Phillip Upchurch  
MICHAEL ENTERPRISES  
P.O. Box 35804  
Tuscon, Arizona 58740

Dear Mr. Upchurch,

I am a cousin of yours and have been casually tracing my family history. Another cousin, Ione Smith Hardin, recently gave me your name and address and suggested that I get in touch with you.

Enclosed, please find a partial list of information that I have. I hope this will be beneficial to you. Also, most of the information that I have has been obtained by word of mouth and not documented. If you find any mistakes, please let me know. If I might have any further information that you can use, please let me know. I will be happy to share anything I know with you.

Please advise me as to where I can get information that you have compiled. I understand that you are the editor of the Upchurch Bulletin and I am also interested in finding out more about this.

I am looking forward to hearing from you soon.

Respectfully yours,

Betty Margaret Hall Battles  
12415 Mullins  
Houston, Texas 77035

7 1 3 7 2 9 - 1 7 7 7

Phone  
no

T.C. M. BATTLES

DESCENDANCY CHART

2

25 Feb 1992

Page 1

- 1-- Moses UPCHURCH-28 (1816)
- sp-Lucinda DICKSON-104
- 2-- James Munroe UPCHURCH-105 (1835)
- 2-- Oliver Hazard UPCHURCH-106 (1838)
- sp-.....-107
- 3-- Moses UPCHURCH-108
- sp-Savannah-112
- 4-- Richard D UPCHURCH-113  (vs WILLIAM CARVER D "DICK") - RPU
- sp-Violet-119
- 4-- Robert Bunion UPCHURCH-114
- sp-Twila CAPPS-120  [vs mrd Cecil "Cecie" Yaker (Gater) - ? - RPU]
- sp-UNKNOWN-121
- sp-Billie Ruth SHIELDS-122
- 4-- Jess UPCHURCH-115
- 4-- Rosie Bell UPCHURCH-116
- 4-- Ethel UPCHURCH-117 (1909)
- sp-Arnold CAPPS-123
- 4-- Maggie Mae P UPCHURCH-118
- 3-- Arthur UPCHURCH-109
- 3-- Ben UPCHURCH-110
- 3-- Will UPCHURCH-111
- sp-UNKNOWN-124
- sp-Nancy LARY-125 (1835)
- 2-- Celia S UPCHURCH-126 (1854)
- sp-C. W. HOWARD-136
- 2-- Riley Judson UPCHURCH-127 (1856)
- sp-Mary P. SANDERS-137 (1858)
- 3-- Elsie Alma UPCHURCH-138 (1880)  [vs PRITCHETT - RPU]
- sp-David "Dave" D PRITCHET-150 (1870)  [vs GERTRUDE IMA W] [RPU]
- 4-- Gertrude Ima PRITCHET-151 (1896)
- 4-- Oris Daniel PRITCHET-152 (1915)
- 4-- Dora Pearl PRITCHET-153 (1919)
- 4-- Doris Myrel PRITCHET-154 (1919)
- 4-- Martha P PRITCHET-155 (1921)
- 3-- Loyl Brently UPCHURCH-146 (1882)
- sp-Esther Belle MILLER-232 (1894)
- 4-- Carmine MILLER-233
- sp-Lee PALMER-234
- 3-- John Raymond B UPCHURCH-142 (1885)
- sp-.....-220
- 4-- Willie UPCHURCH-221
- 4-- A. J. UPCHURCH-222
- 3-- Nancy Jane UPCHURCH-139 (1887)
- sp-Walter Sherwood BROWN-156 (1887)
- 4-- Robert Riley BROWN-157 (1906)
- sp-.....-162
- 4-- E.? Lois BROWN-158 (1908)
- sp-Milton ADAMS-163
- 4-- Cleo Iola BROWN-159 (1911)
- sp-..... LEVERETT-164
- 4-- Walter Truman BROWN-160 (1920)
- sp-Temple WILLIS-161 (1919)
- 5-- Ronnie BROWN-165 (1942)
- 5-- Helen Kaye BROWN-166 (1947)
- 3-- Agnes UPCHURCH-140
- sp-Tom BROWN-167

## DESCENDANCY CHART

3

25 Feb 1992

Page 2

4-- Philip BROWN-168                   △  
 3-- Henry Jacob H UPCHURCH-141 (1893) △  
 sp-Elsie Marie HUBLER-169 (1896)     △  
 4-- Philip Loyl UPCHURCH-170 (1915) △  
 sp-Vera Julia CAPPs-175 (1906)       △  
   5-- Melva Jean UPCHURCH-176 (1939) △  
     sp-Edward Francis DANIELS-179     △  
       6-- Edward Francis DANIELS-180 (1967) △  
   5-- Philip Ray UPCHURCH-177 (1940)   △  
     sp-Shirley SCROGGINS-181 (1936)   △  
       6-- Charles Timothy GRAVES-182 (1956) △  
       6-- Travis Lee T UPCHURCH-183 (1967) △  
       6-- Phillip Trent UPCHURCH-184 (1973) △  
   5-- Wanda Faye UPCHURCH-178 (1942)   △  
     sp-Johnny WELCH-185 (1940)        △  
       6-- Carol Jean WELCH-186 (1965)   △  
         sp-Thomas Lynn SKELTON-560 (1962) △  
           7-- Terry Lynn SKELTON-561 (1983) △  
           7-- Clayton John SKELTON-562 (1985) △  
       6-- Johnny Faye WELCH-187 (1969)   △  
       6-- Adam Jeff Tharp WELCH-188 (1970) △  
     sp-Lala HOLLAND-189 (1924)        △  
   4-- Marie Louise UPCHURCH-6 (1917)    △  
     sp-Eldred Arthur HALL-5 (1913)     △  
       5-- Arthur Duane HALL-7 (1937)     △  
         sp-Kathryn E DEUBER-10 (1944)    △  
           6-- Duane Eldred HALL-11 (1966) △  
           6-- Sherri Ann HALL-12 (1972)   △  
         sp-Carol WRIGHT-192 (1946)       △  
         sp-Jeddie Marie MAGROGAN-193 (1944) △  
           6-- Tessamae J TORRES-194 (1971) △  
       5-- Melba Ann HALL-8 (1942)       △  
         sp-Jerry Ben HARGRAVE-13 (1939)   △  
           6-- Marie Annette R HARGRAVE-14 (1962) △  
             sp-Craig Stephen CLANTON-30 (1960) △  
               7-- Joshua Aaron CLANTON-31 (1989) △  
               7-- Stephanie Marie CLANTON-32 (1990) △  
           6-- Tracy Ann HARGRAVE-15 (1966) △  
             sp-Phillip Wayne GRIMES-33 (1966) △  
             sp-Kelly Dean ACKER-34 (1967)   △  
       5-- Raymond Leo HALL-9 (1944)       △  
       5-- Betty Margaret HALL-2 (1945)    △  
         sp-Carl Richard BATTLES-1 (1940)   △  
           6-- Richard Andrew BATTLES-3 (1968) △  
           6-- James Alan BATTLES-4 (1972)   △  
   4-- Raymond H UPCHURCH-172 (1920)     △  
     sp-Eva Nell BYERS-195 (1924)        △  
       5-- Elizabeth L UPCHURCH-196 (1958) △  
         sp-Clifton Andrew TOON-198       △  
           6-- Clifton Aaron TOON-199 (1975) △  
           6-- Cinnamon Candice TOON-200 (1977) △  
           6-- Ronnie .....-201        △ → [Ronnie Wdnt? - RPA]  
             sp-Keys BORDVINE-202 (1945)   △  
       5-- Leslie Ray UPCHURCH-197 (1959) △  
   4-- Dorothea M UPCHURCH-173 (1923)   △  
     sp-Walton B PHILLIPS-203 (1920)     △



DESCENDANCY CHART

- 5-- Charles Eddie PHILLIPS-204 (1947) △
- sp-Barbara Ann REDD-207 (1949) △
- 6-- David Wayne PHILLIPS-208 (1974) △
- 6-- Alison Marie PHILLIPS-209 (1979) △
- 5-- Belinda Sue PHILLIPS-205 (1959) △
- sp-Mark HESS-210 (1958) △
- 6-- Amy Elizabeth HESS-211 (1983) △
- 6-- Abby Nicole HESS-212 (1985) △
- 6-- Andrew HESS-213 (1988) △
- 5-- Joy Annette PHILLIPS-206 (1961) △
- sp-Edward GONZALES-214 (1954) △
- 6-- Tiamo S GONZALES-215 (1985) △
- 4-- Charles Henry UPCHURCH-174 (1927) △
- sp-Elizabeth T BEASLEAY-216 (1939) △
- 5-- Charles R UPCHURCH-217 (1960)
- 5-- Patricia Gail UPCHURCH-218 (1962)
- sp-Louise (Luten) BRASHER-219 (1931) △
- 3-- Mary UPCHURCH twin-143 (1895) □
- sp-Ted MOBLEY-223 □
- 4-- Loyl Brently MOBLEY-224 △
- 3-- Martha UPCHURCH twin-144 (1895) □
- sp-George E. B WOOTEN-225 (1881) □
- 4-- Trevel WOOTEN-227 △
- 4-- Mavis WOOTEN-226 △
- sp-J. T. RIGBY-228 △
- 5-- Johnny WOOTEN-229 △
- 5-- Pat WOOTEN-230 △
- 3-- Etta UPCHURCH-145 □
- sp-Joe ISBEL-231 □
- 3-- Marcus UPCHURCH-147 □
- sp-Pearl DUDLEY-235 □
- 3-- Judson Weldon UPCHURCH-148 (1900) □
- 3-- Nevada UPCHURCH-149 □
- sp-Frank ISBEL-236 □
- 4-- Gladys ISBEL-237 △
- sp-Malcolm WADE-239 △
- 4-- Jewel Barnis ISBEL-238 △
- sp-..... CRUTCHFIELD-240 -
- 5-- Charles G CRUTCHFIELD-241 △
- sp-Sylvia .....-242 -
- 6-- Jonathan CRUTCHFIELD-243 △
- 2-- Texanna o UPCHURCH-128 □
- 2-- Milton Ernest UPCHURCH-129 (1859) □
- sp-Mary Ann CARTER-244 (1857) □
- 3-- Walter UPCHURCH-245 □
- sp-Ethel Aline .....-251 (1882) □
- 4-- Juanita UPCHURCH-252 □
- 4-- Arvita UPCHURCH-253 △
- 4-- Phillip Allen UPCHURCH-254 □
- 3-- Betty UPCHURCH-246 △
- sp-C. CAPPS-255 □
- 4-- Neil CAPPS-256 △
- sp-Oris DYER-261 △
- 4-- Erma CAPPS-257 □
- sp-Claude PYLE-262 □
- 4-- Hood CAPPS-258 △

} [with WOOTEN ? - RPU]

DESCENDANCY CHART

25 Feb 1992

Page 4

- sp-Flossie PYLE-263     △
- 4-- Robert CAPPS-259   △
- sp-.....-264         □
- 4-- Quentin CAPPS-260   △
- sp-.....-265         □
- 3-- Carvin E. M UPCHURCH-247 (1883)△
- sp-Lula BALLARD-266 (1885)   □
- 4-- Clifford UPCHURCH-267   □
- 3-- Jennie UPCHURCH-249 (1885) △
- sp-Fritz Hans HUBLER-271 (1883) △
- 4-- Hazel Captola HUBLER-272 (1911) △
- sp-Franklin PEYTON-276 (1912) □
- 4-- Willard Milton HUBLER-273 (1914) △
- 4-- Wilbert Adolph HUBLER-274 (1914) △
- 4-- William Doyle HUBLER-275 (1918) △
- sp-Vera .....-277         □
- 5-- William Doyle HUBLER J-278   △
- 3-- Robert C UPCHURCH-248 (1888) □
- sp-Jennie BALLARD-268 (1891)   □
- 4-- Bertha UPCHURCH-269       □
- 4-- Kelly UPCHURCH-270       □
- 3-- Iona L. UPCHURCH-250 (1898) □
- 2-- Robert E. Lee UPCHURCH-130 (1861) □
- sp-Willie HARRISON-279 (1867)   □
- sp-Fannie Verna DAVIS-280 (1890) □
- 3-- Robert E. Lee UPCHURCH I-281 (1922) □
- sp-Mary Kathryn DYER-282       □
- 4-- Mary Candice C UPCHURCH-283 (1953) □
- sp-William Floyd CONRAD-286     □
- 4-- Kathryn Lois UPCHURCH-284 (1955) □
- 4-- Robert E. Lee UPCHURCH I-285955 (1963) □
- 2-- John Bunion UPCHURCH-132     □
- 2-- Ionia E. UPCHURCH-133 (1868) □
- sp-J. M. WHEELER-190           □
- 2-- Martha Paralee UPCHURCH-80 (1868) □
- sp-Samuel Andrew ISBEL-87       □ → [vs -- ISBEL - RPU]
- 3-- Aaron ISBEL-88             □
- sp-Lillie-91                   □
- 4-- Clyde ISBEL-92             △
- 4-- Rupert ISBEL-93           △
- 4-- Paralee ISBEL-94          △
- 4-- Ernest ISBEL-95           □
- 3-- Zula ISBEL-89              □
- sp-Beverly HARRISON,M.D.-96 (1874) □
- 4-- Lucy Loree HARRISON-97     △
- 4-- Willie Ione HARRISON-98   △
- 4-- Samuel Beverly HARRISON-99 △
- 3-- Fred ISBEL-90              □
- sp-Abbie-100                  □
- 4-- Christine ISBEL-101       △
- 4-- Herman ISBEL-102         △
- 4-- W. F. ISBEL-103         △
- 2-- Armina L UPCHURCH-134     □
- 2-- Joseph Clyde UPCHURCH-135 □

7. - RPA

Henry Jacob Hall UPCHURCH-141  
b: 7 Jan 1893  
d: 29 Nov 1914 --51 Bedias, Grimes, Texas  
o: 3 Jul 1929

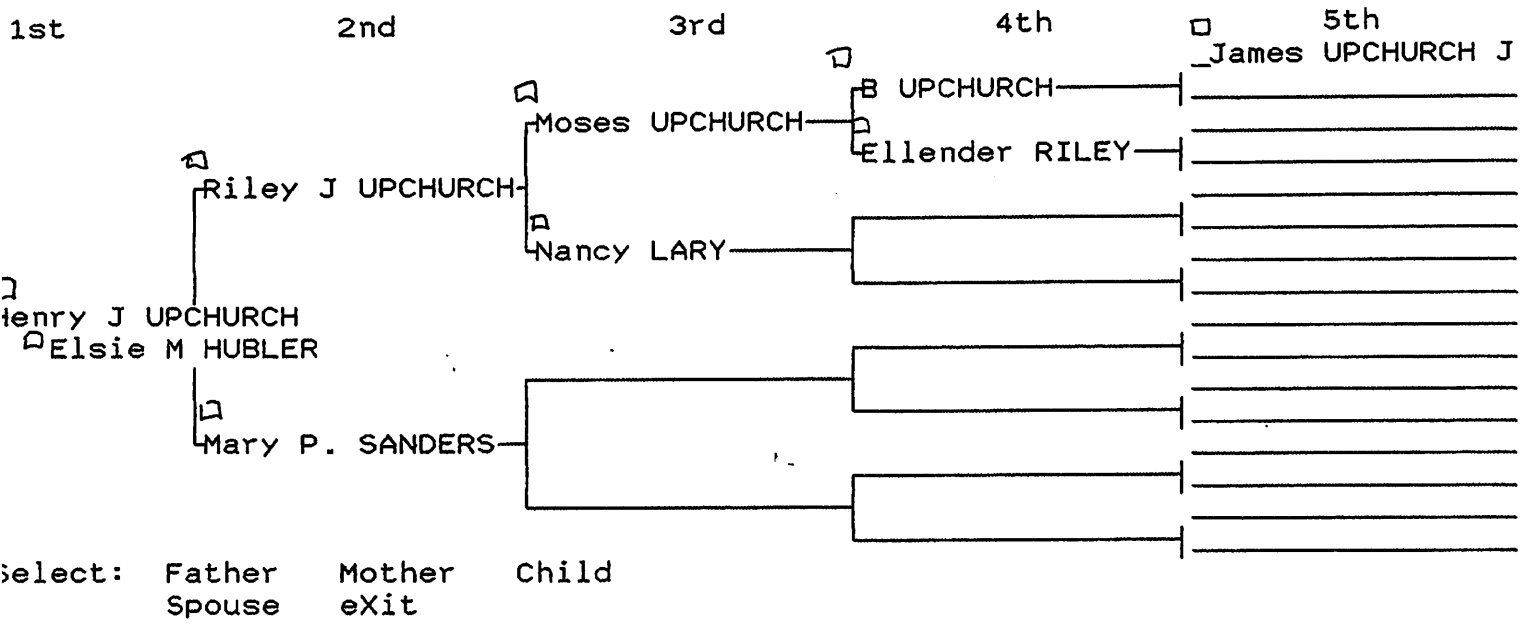

Elsie Marie HUBLER-169  
b: 7 Feb 1896                      Bedias, Grimes, Texas  
d: 29 Nov 1914 --51                Bedias, Grimes, Texas  
o: 13 Jul 1968                      Houston, Harris, Texas

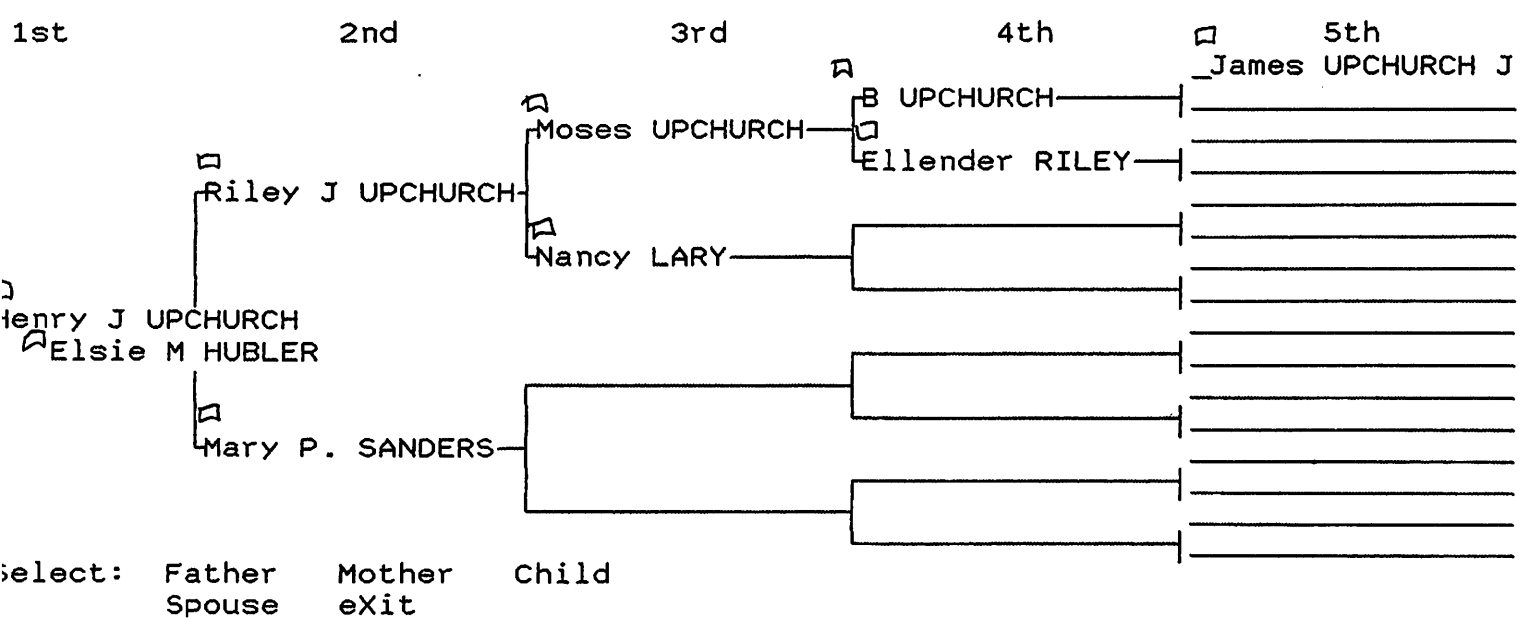

Philip Loyl UPCHURCH-170  
B: 4 Dec 1915  
M: --52  
D:

Bedias, Grimes, Texas

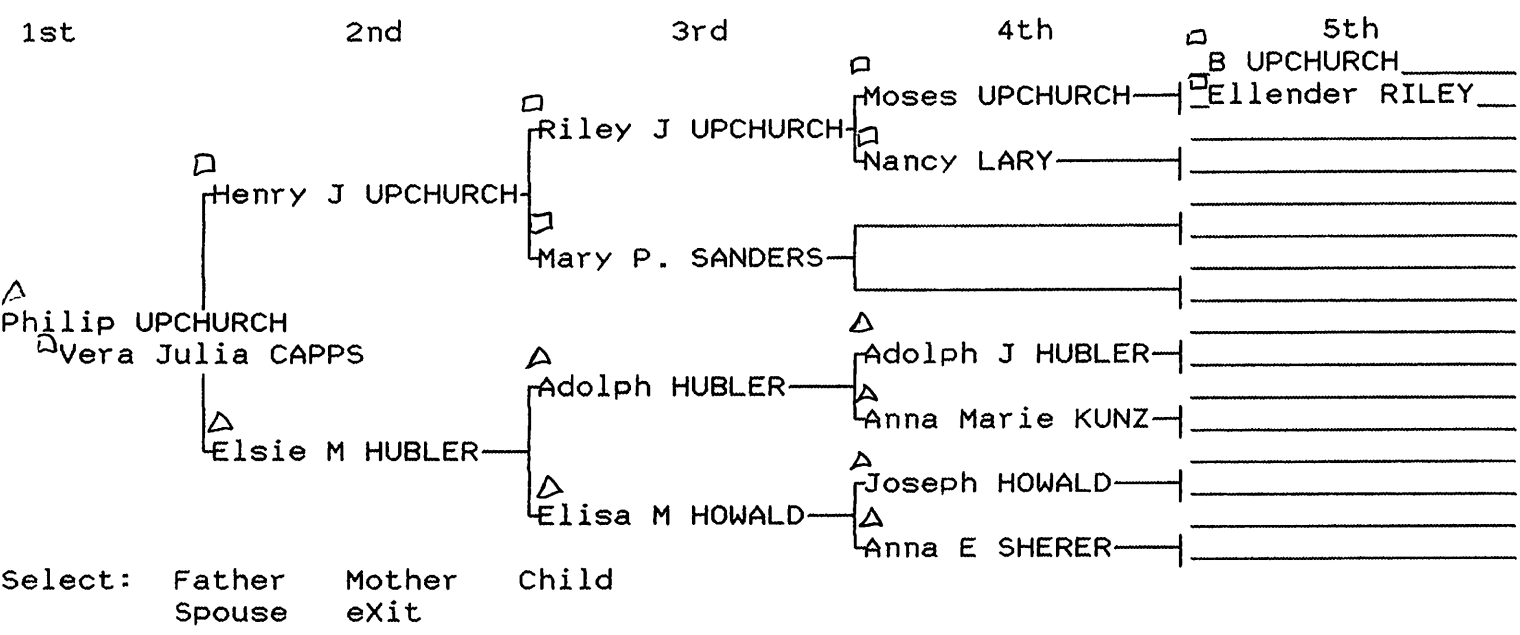

Vera Julia CAPPS-175  
B: 17 Aug 1906  
M: --52  
D: 8 Jan 1975

Bedias, Grimes, Texas

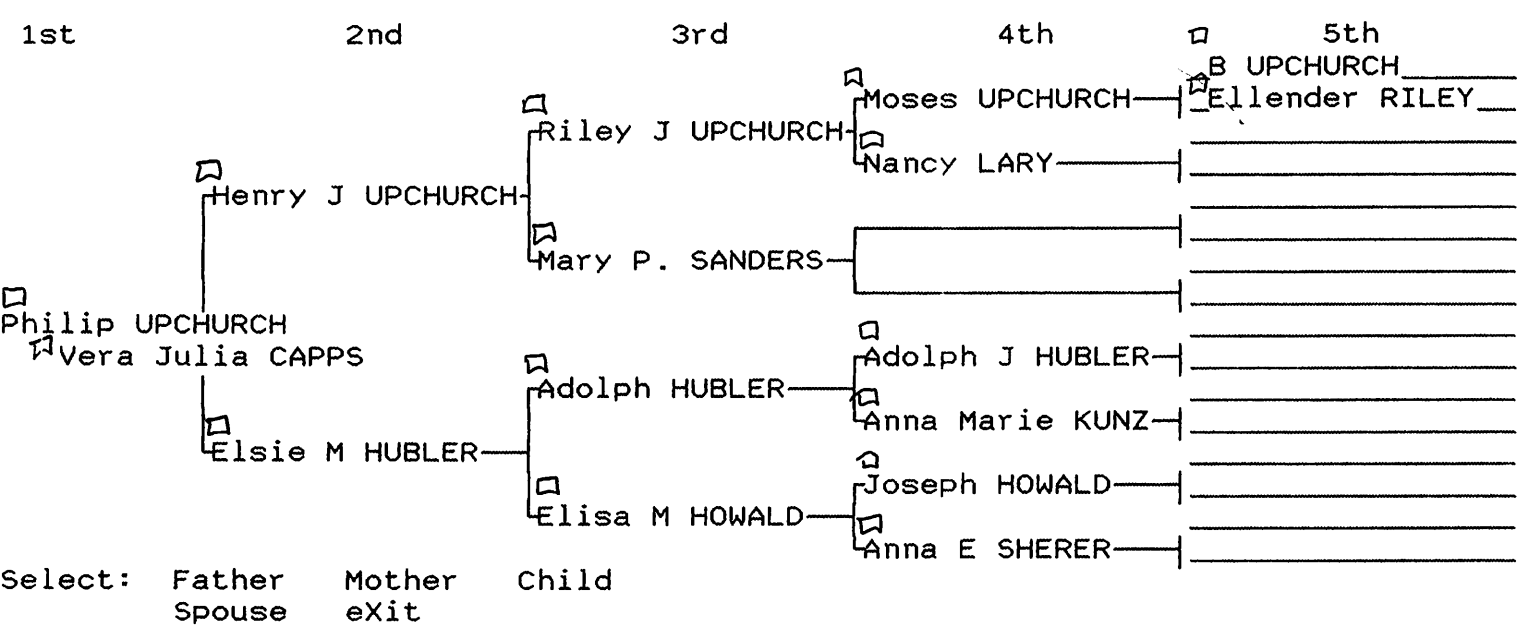

Melva Jean UPCHURCH-176  
B: 12 Jan 1939  
M: --53  
D: 5 May 1973

Bedias, Grimes, Texas  
Bedias, Grimes, Texas

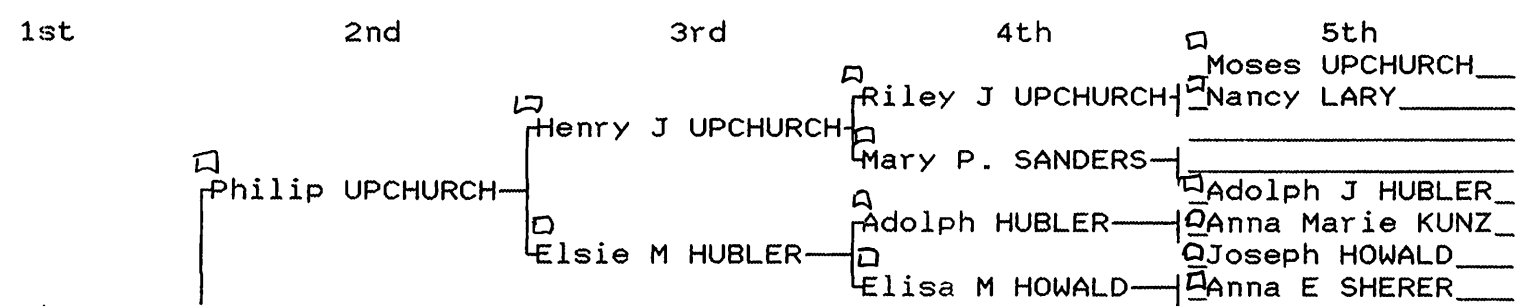

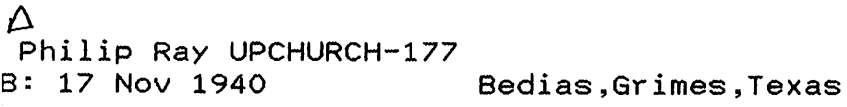
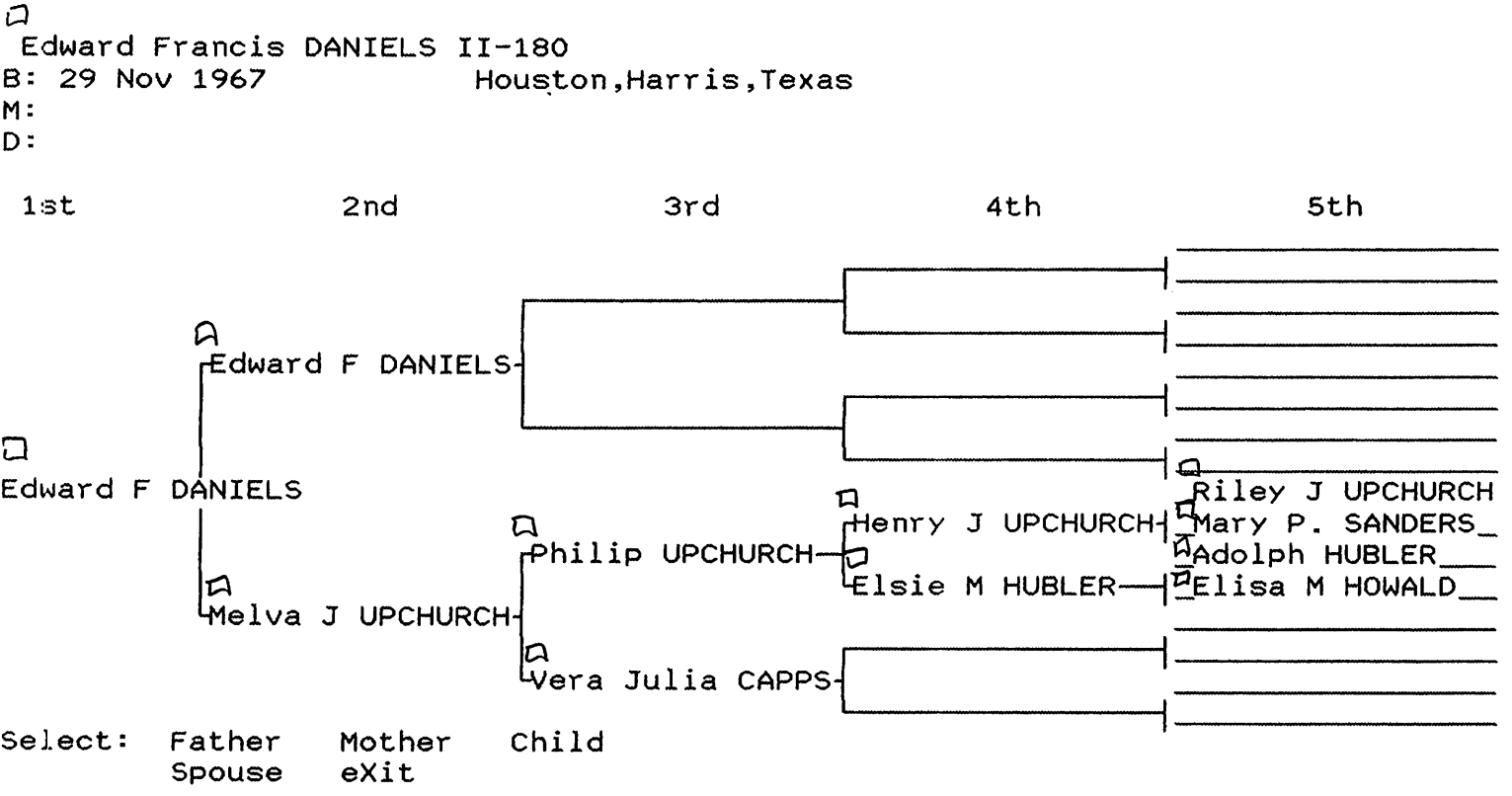
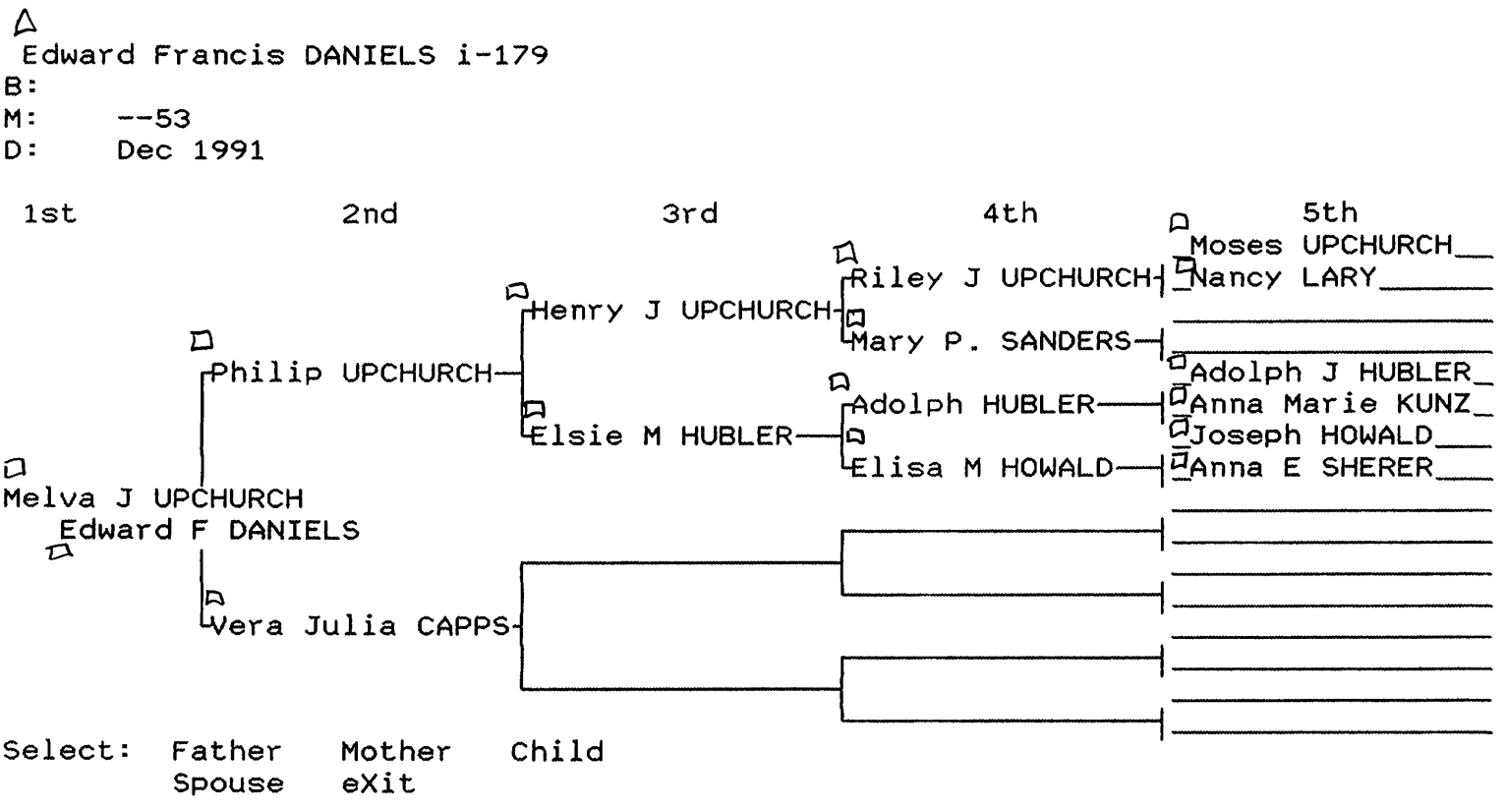
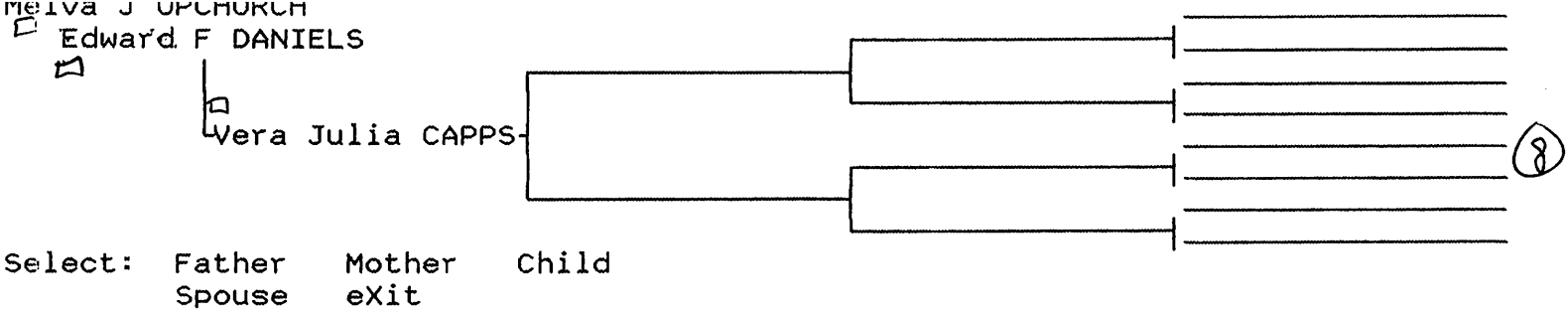

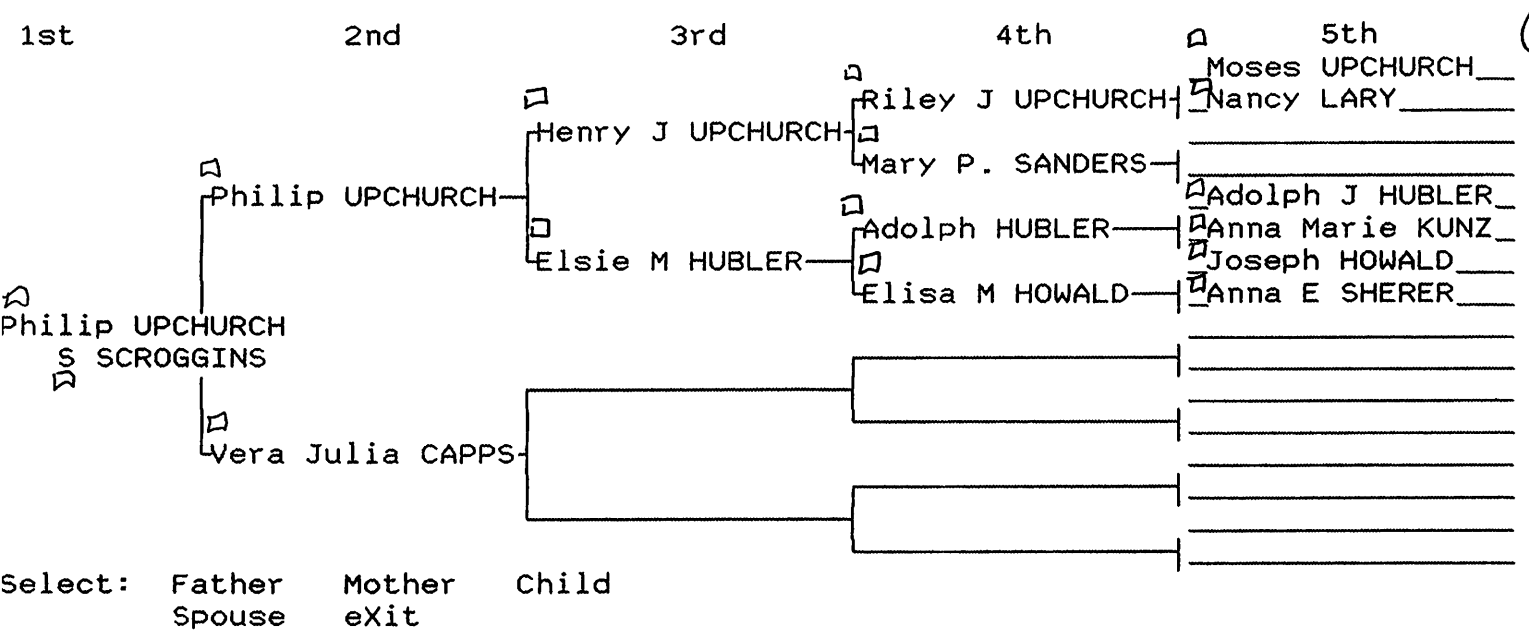

△  
Shirley SCROGGINS-181  
B: 6 Dec 1936  
M: --54  
D:

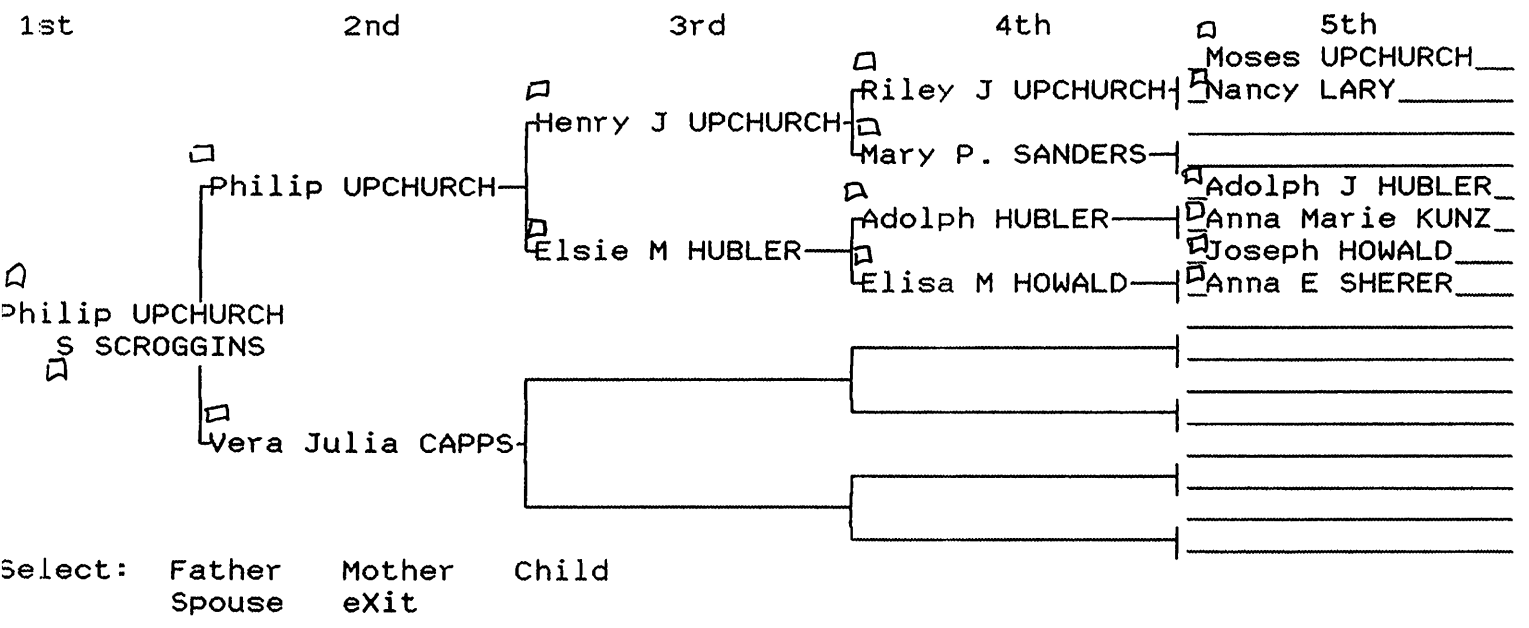

△  
Charles Timothy GRAVES-182  
B: 14 May 1956  
M:  
D:

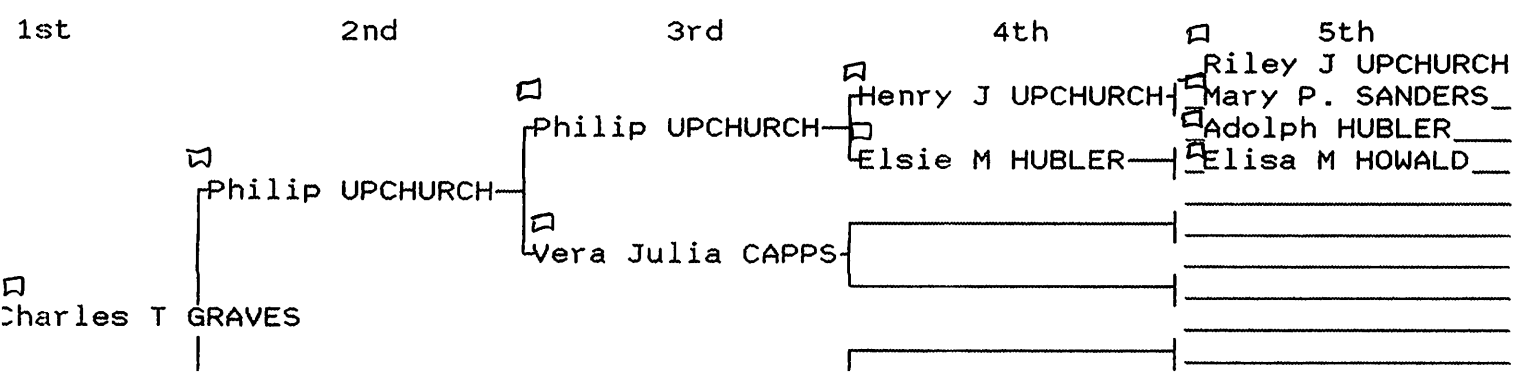

△  
Charles T GRAVES



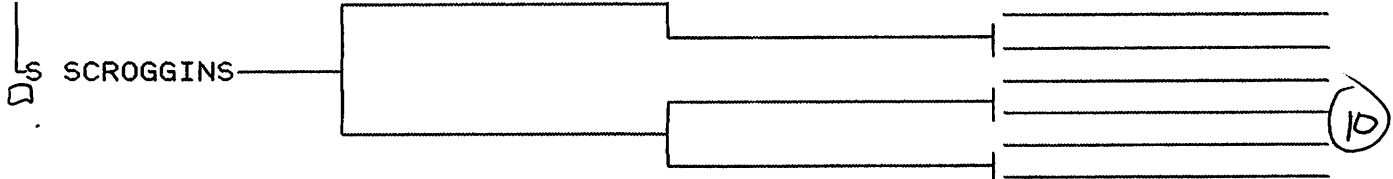

Select: Father Spouse Mother eXit Child

△  
 Travis Lee Tharp UPCHURCH-183  
 B: 5 Oct 1967  
 M:  
 D:

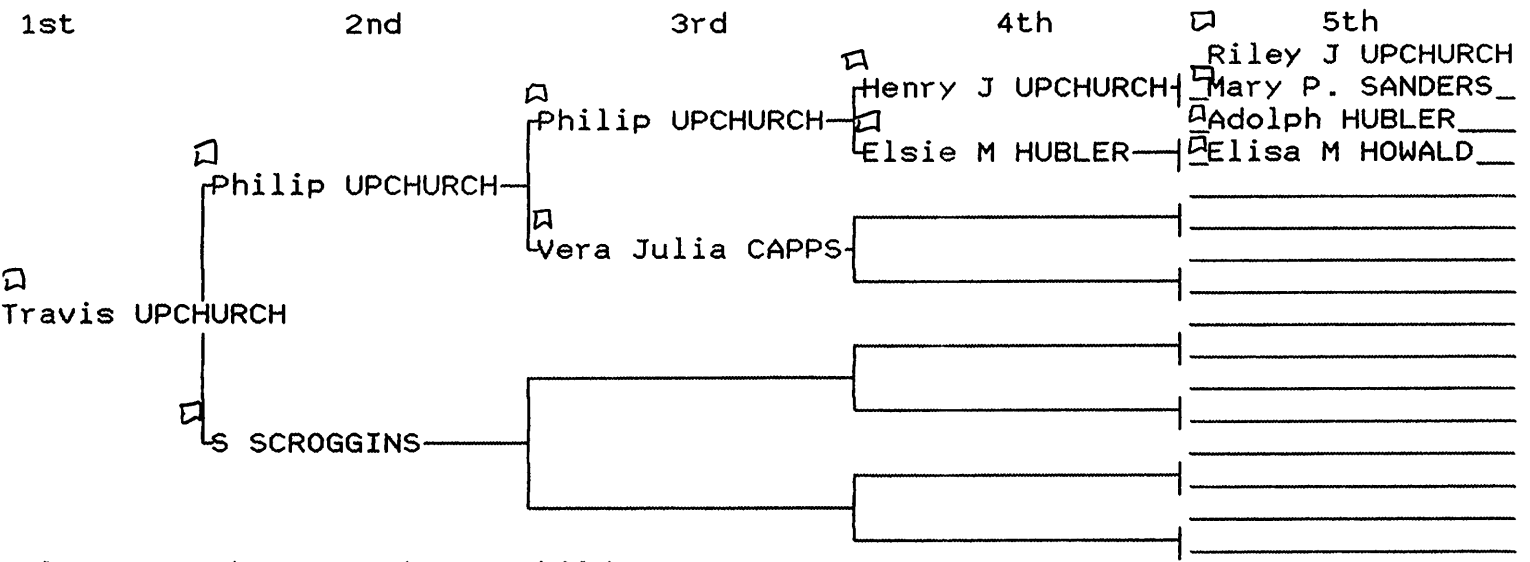

Select: Father Spouse Mother eXit Child

△  
 Phillip Trent UPCHURCH-184  
 B: 20 Jun 1973  
 M:  
 D:

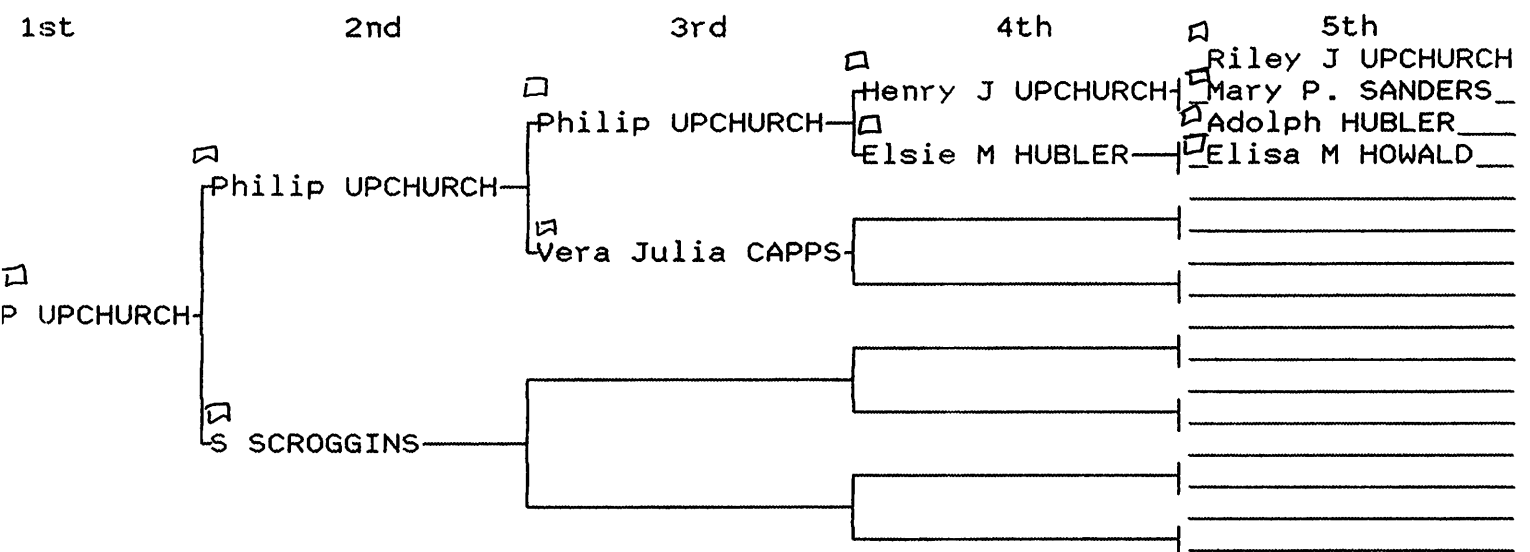

Select: Father Spouse Mother eXit Child

△  
 Wanda Faye UPCHURCH-178  
 B: 4 Oct 1942 Bedias, Grimes, Texas  
 M: --55  
 D: 9 Jan 1986 Abbott, Texas

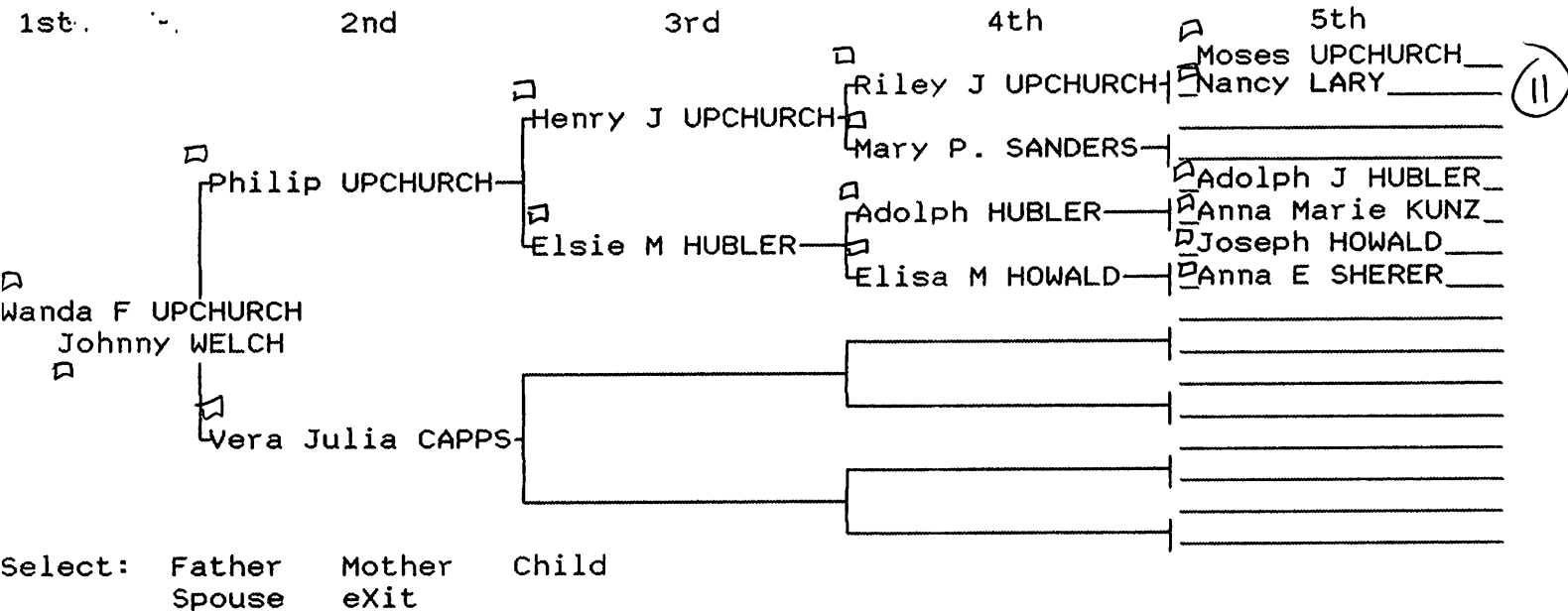

△  
Johnny WELCH-185  
B: 29 Jul 1940  
M: --55  
D:

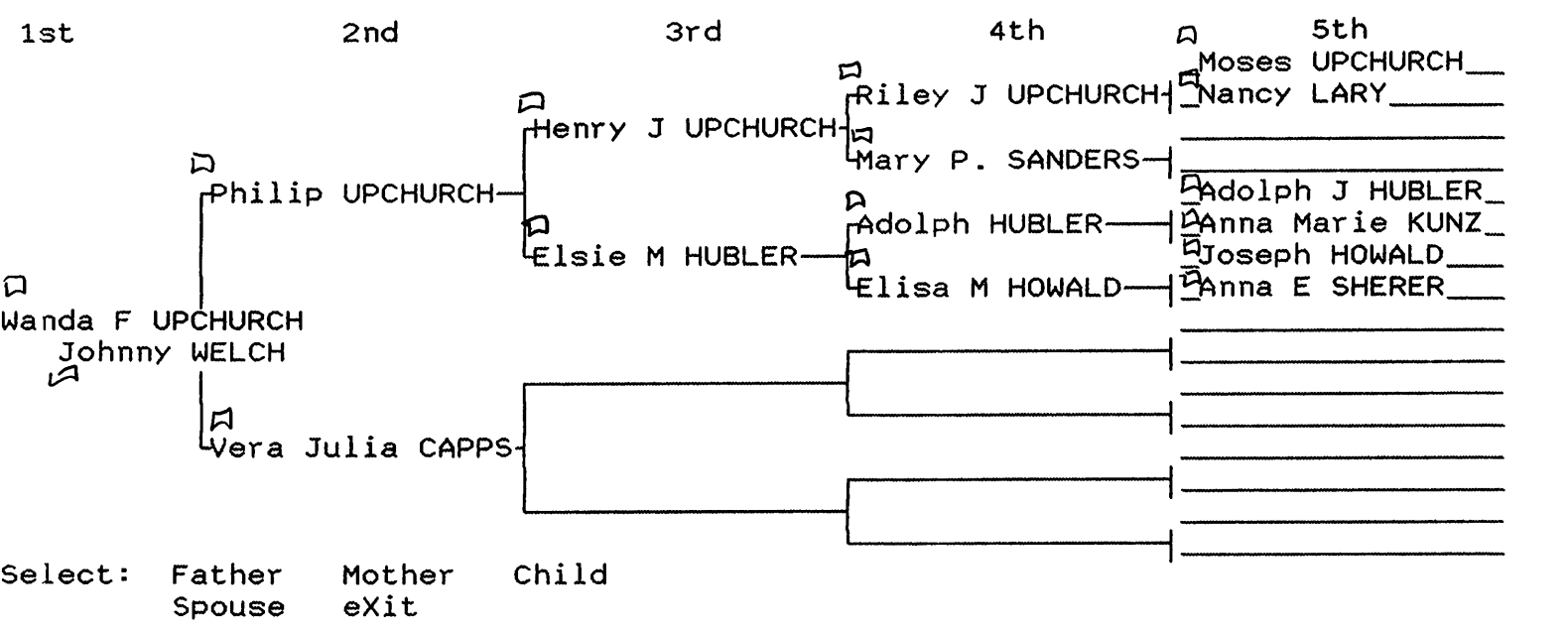

△  
Carol Jean WELCH-186  
B: 12 Feb 1965  
M: (div) --201  
D:

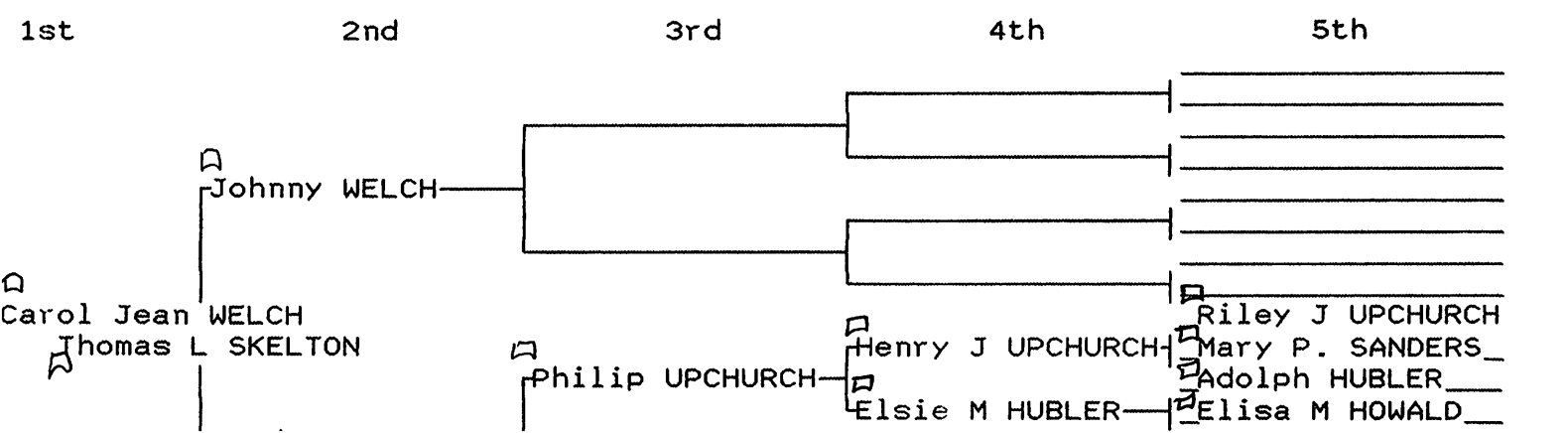

Wanda F UPCHURCH

Vera Julia CAPPS

Select: Father Spouse Mother eXit Child

12

Thomas Lynn SKELTON-560  
B: 13 Aug 1962  
M: (div) --201  
D:

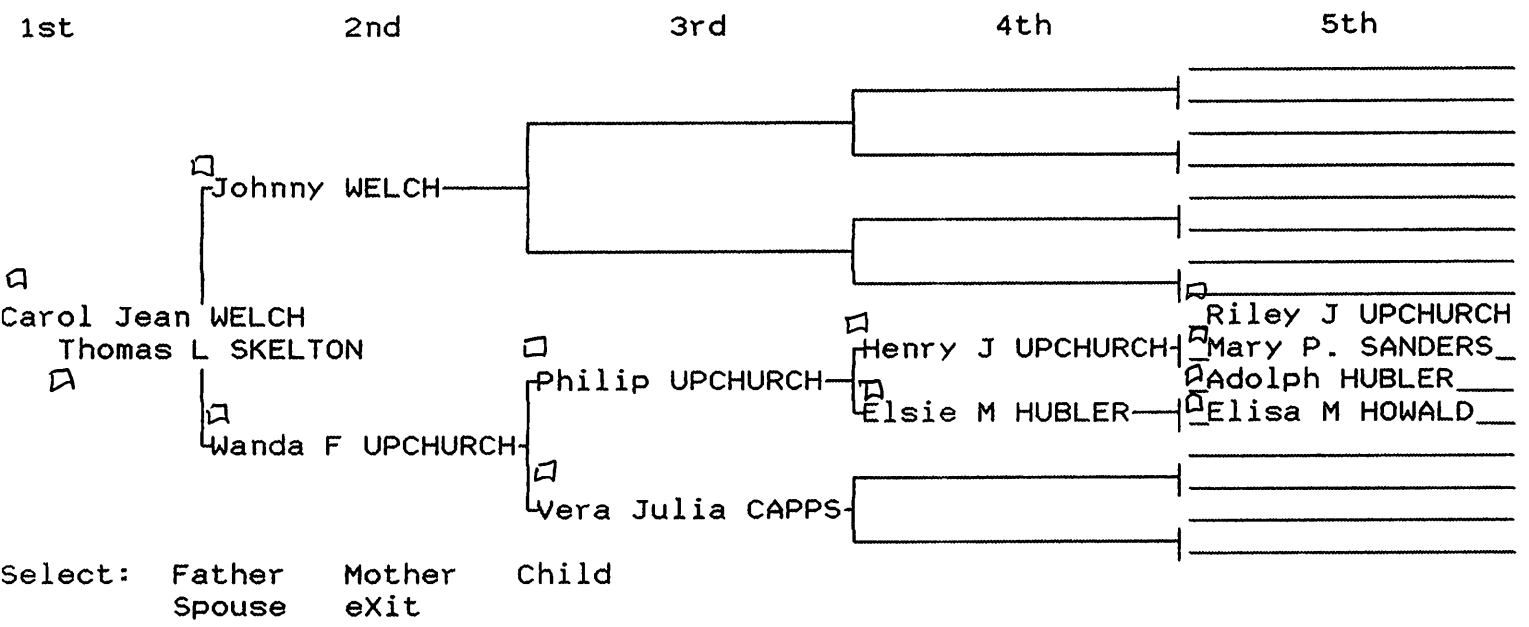

Terry Lynn SKELTON-561  
B: 8 Aug 1983  
M:  
D:

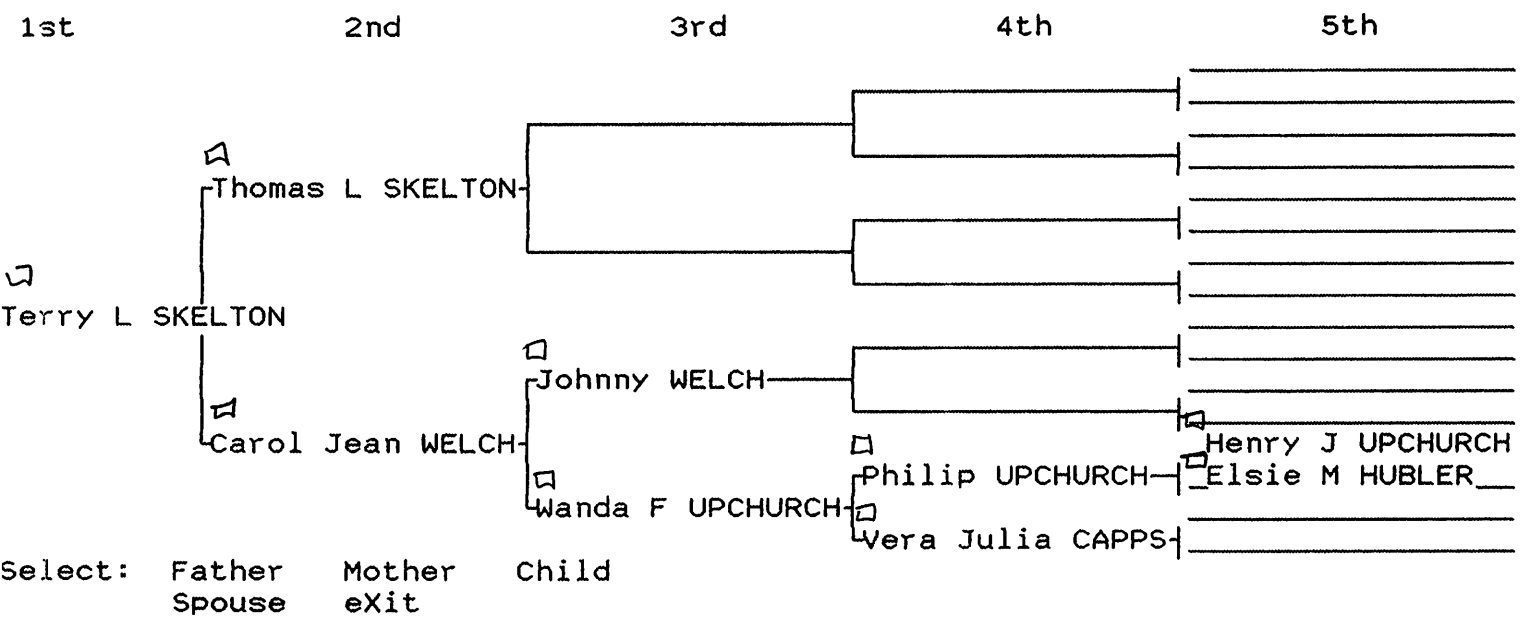

Clayton John SKELTON-562  
B: 8 Jan 1985  
M:  
D:



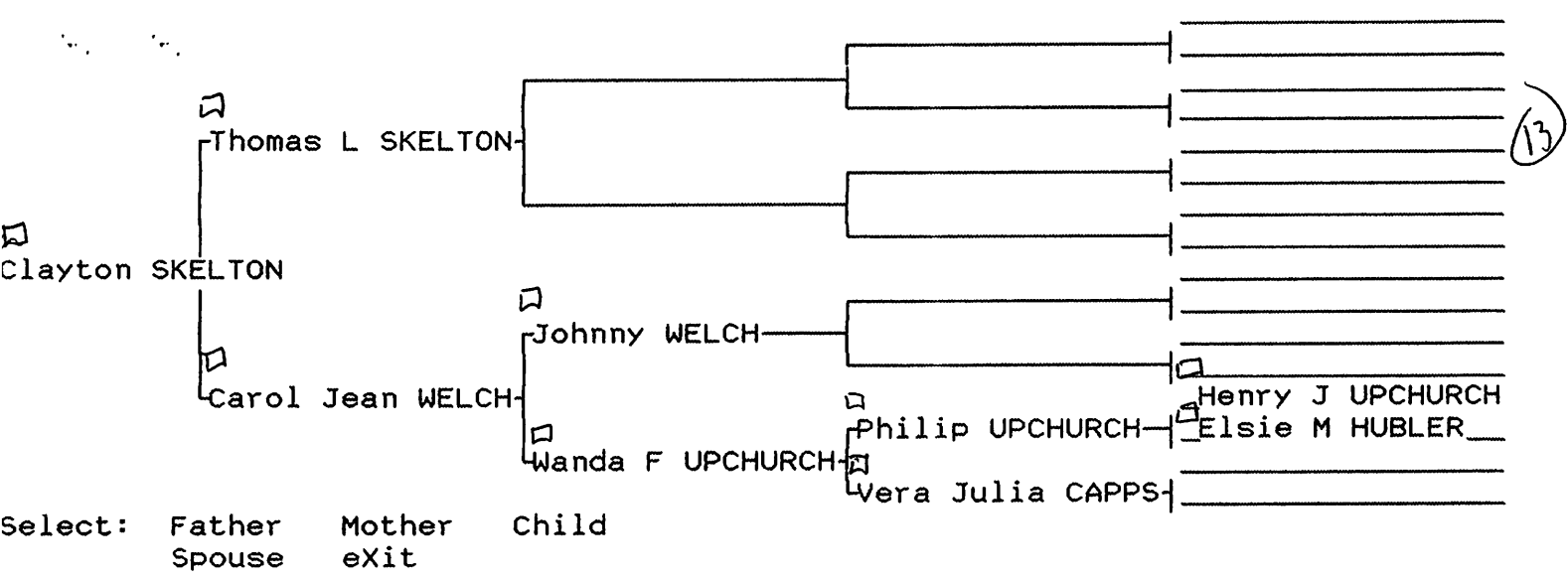

△ Johnny Faye WELCH-187  
 B: 22 Aug 1969  
 M:  
 D:

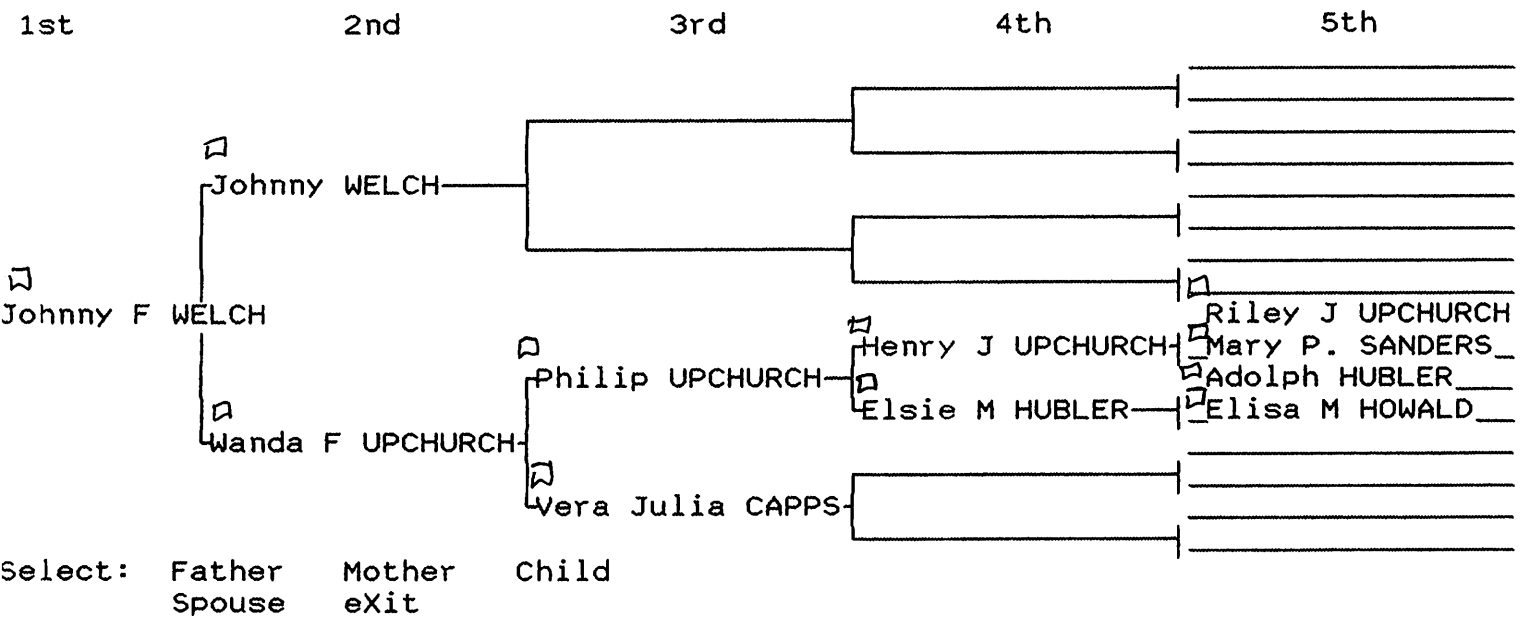

△ Adam Jeff Tharp WELCH-188  
 B: 11 Oct 1970  
 M:  
 D:

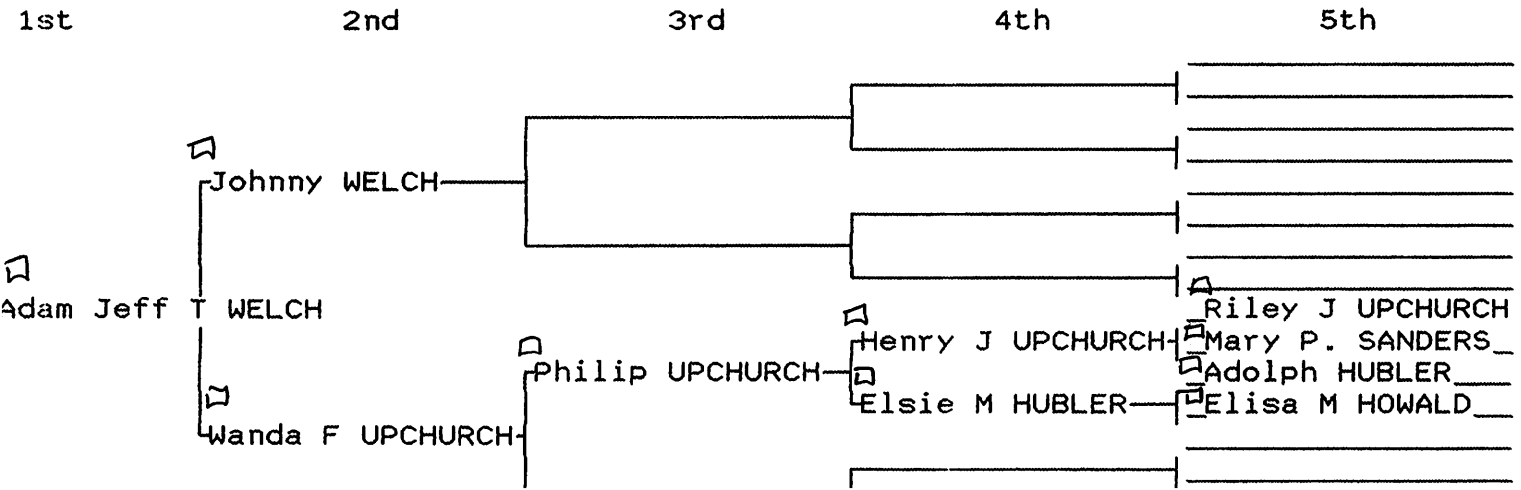

Select: Father Spouse Mother eXit Child

(14)

△  
 Lala HOLLAND-189  
 B: 8 Apr 1924  
 M: 7 May 1983 --56 Bedias,Grimes,Texas  
 D:

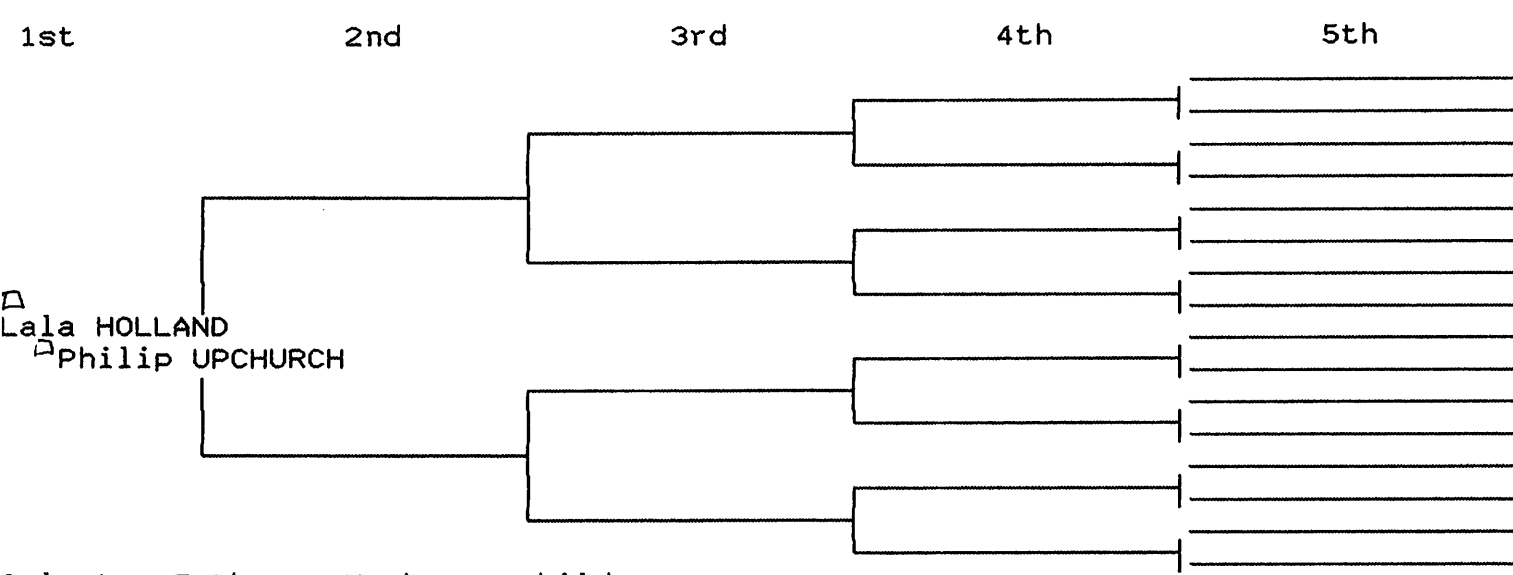

Select: Father Spouse Mother eXit Child

△  
 Marie Louise UPCHURCH-6  
 B: 15 Sep 1917 Bedias,Grimes,Texas  
 M: 22 Feb 1936 --2 Bedias,Grimes,Texas  
 D:

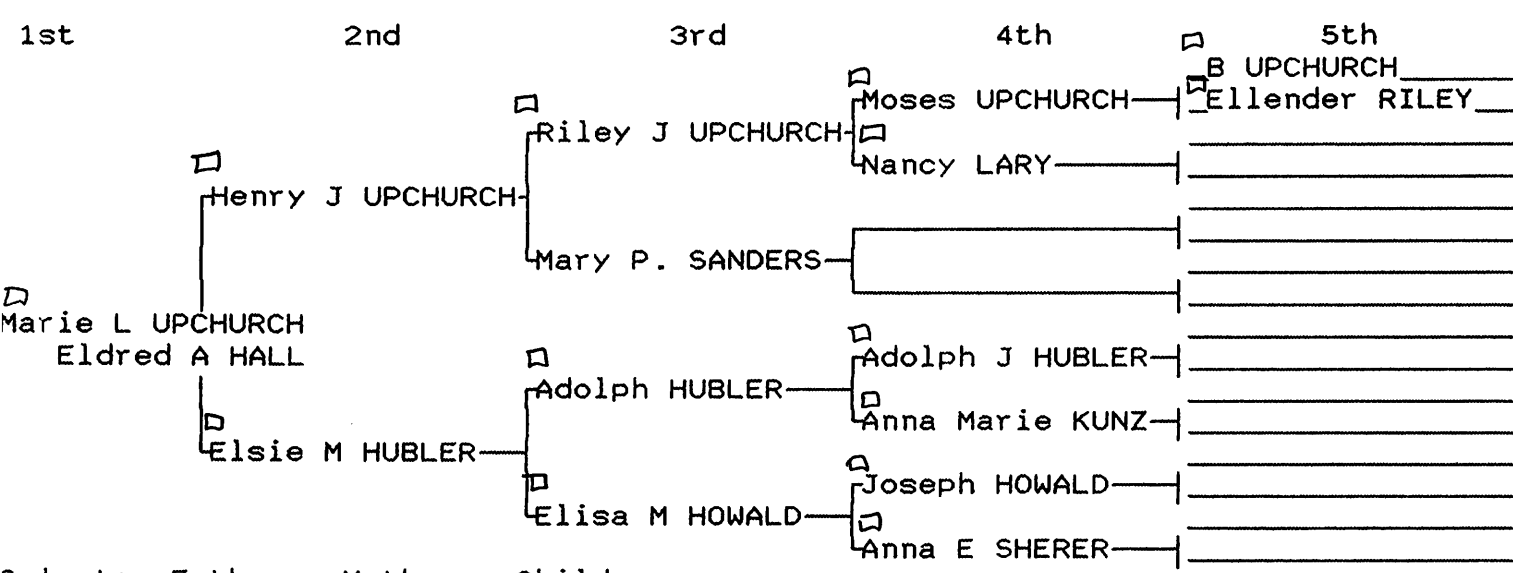

Select: Father Spouse Mother eXit Child

△  
 Eldred Arthur HALL-5  
 B: 29 May 1913 Bedias,Grimes Co.,Texas  
 M: 22 Feb 1936 --2 Bedias,Grimes,Texas  
 D: 16 Mar 1981 Houston,Harris Co.,Texas

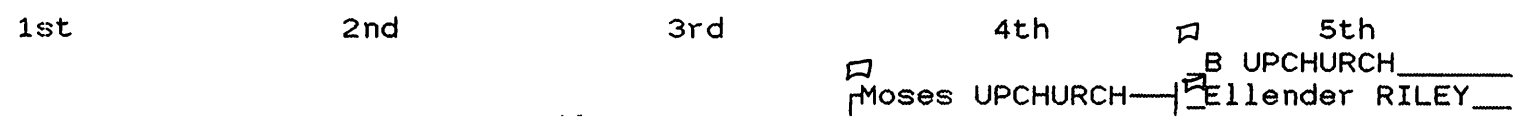

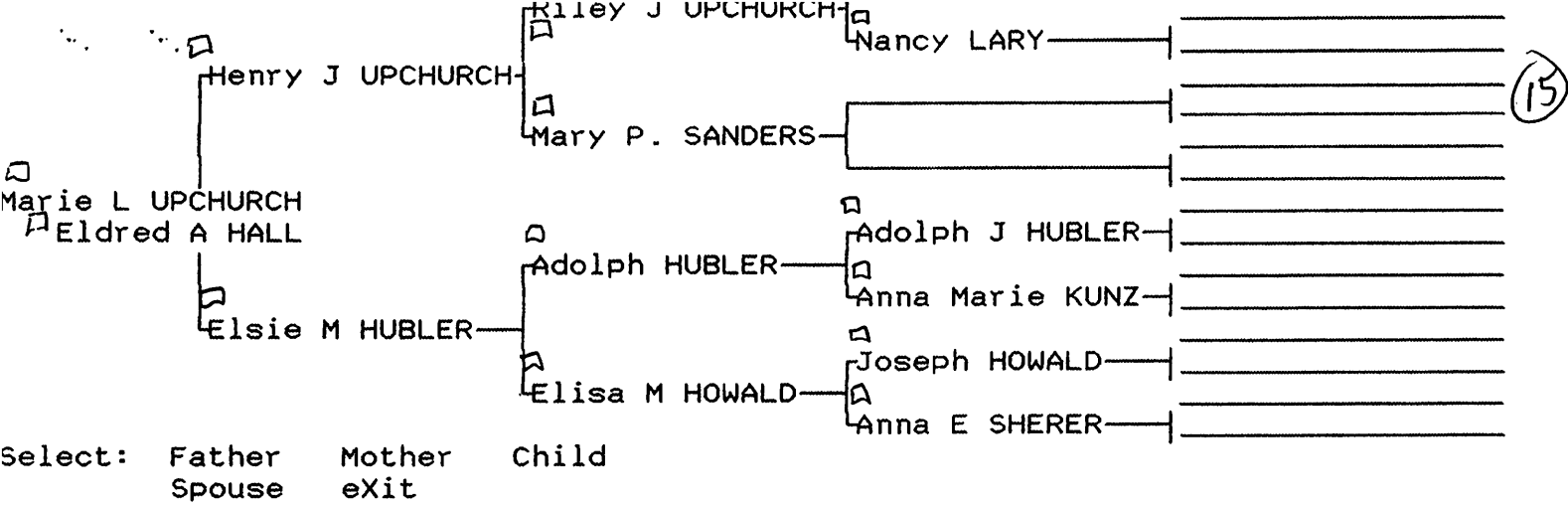

Arthur Duane HALL-7  
 B: 15 Sep 1937                      Bedias, Grimes, Texas  
 M: 1963(div) --3                    , , Germany  
 D:

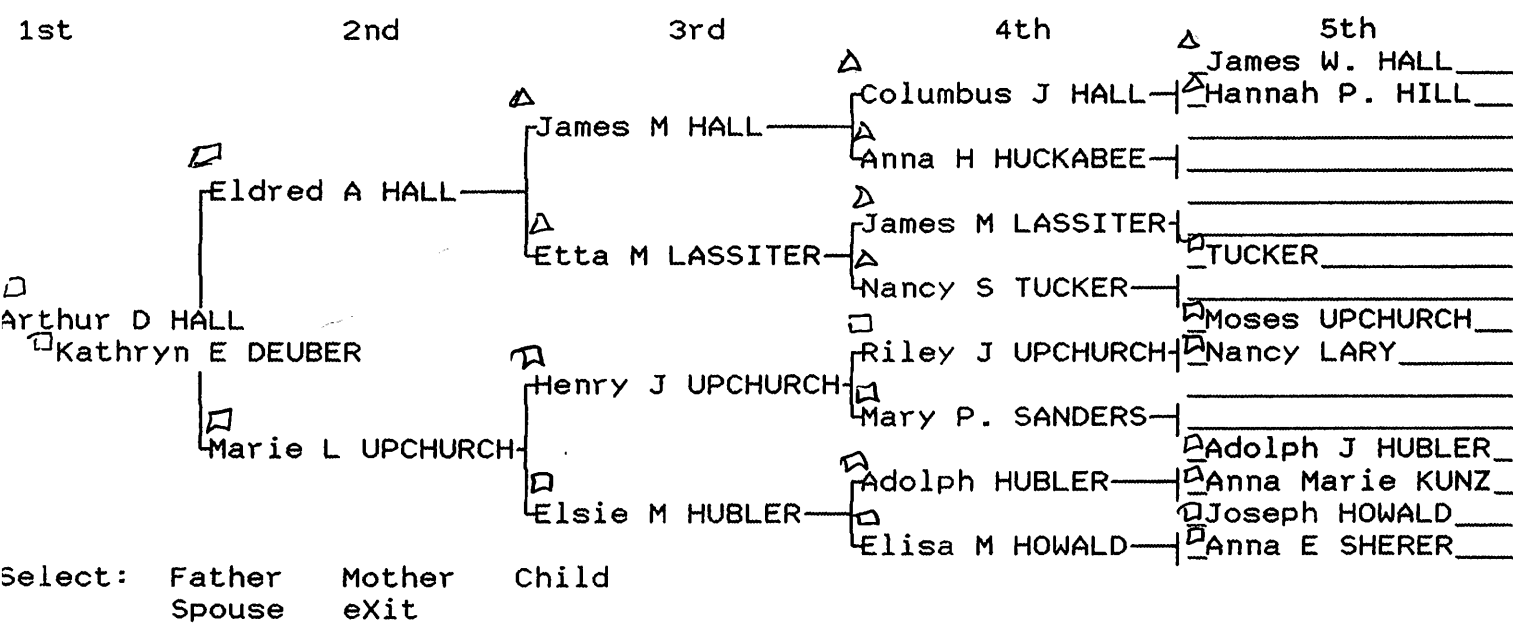

Kathryn Elizabeth DEUBER-10  
 B: 29 Mar 1944                      Camden, , New Jersey  
 M: 1963(div) --3                    , , Germany  
 D: 6 Feb 1981                      Conroe, Montgomery, Texas

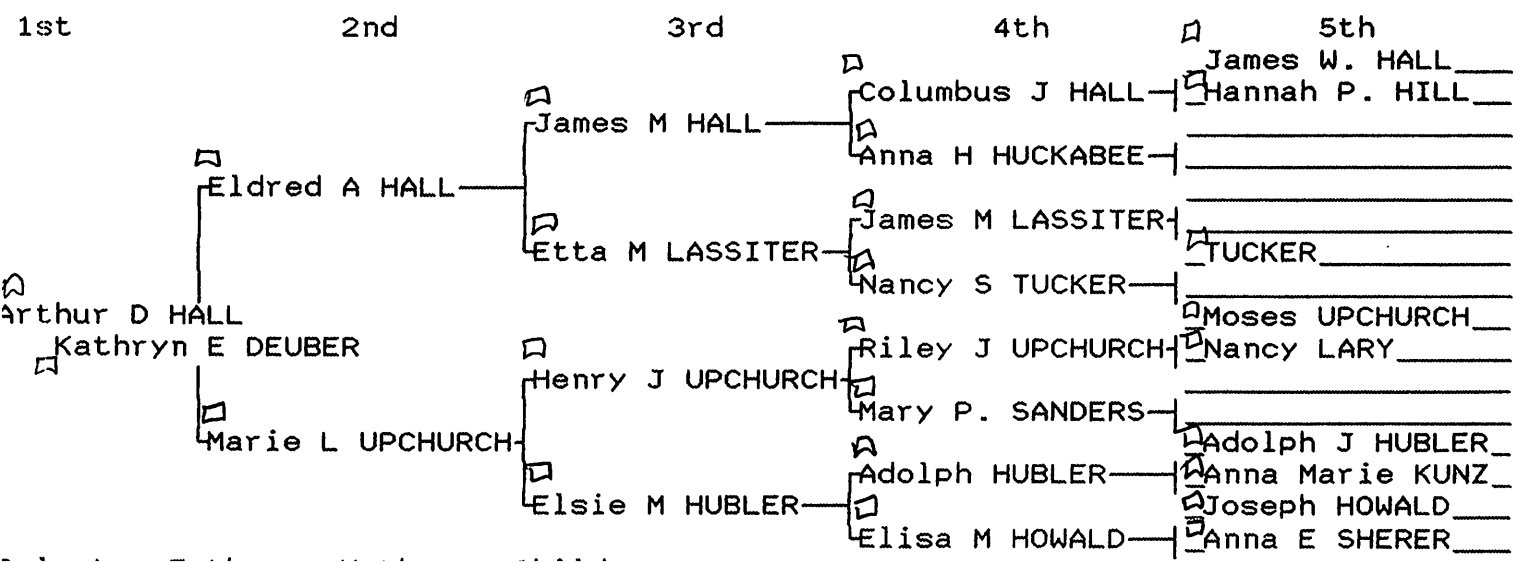

Select: Father Mother Child  
Spouse eXit

16

△  
Duane Eldred HALL-11  
B: 10 Feb 1966  
M:  
D:  
Camden,,New Jersey

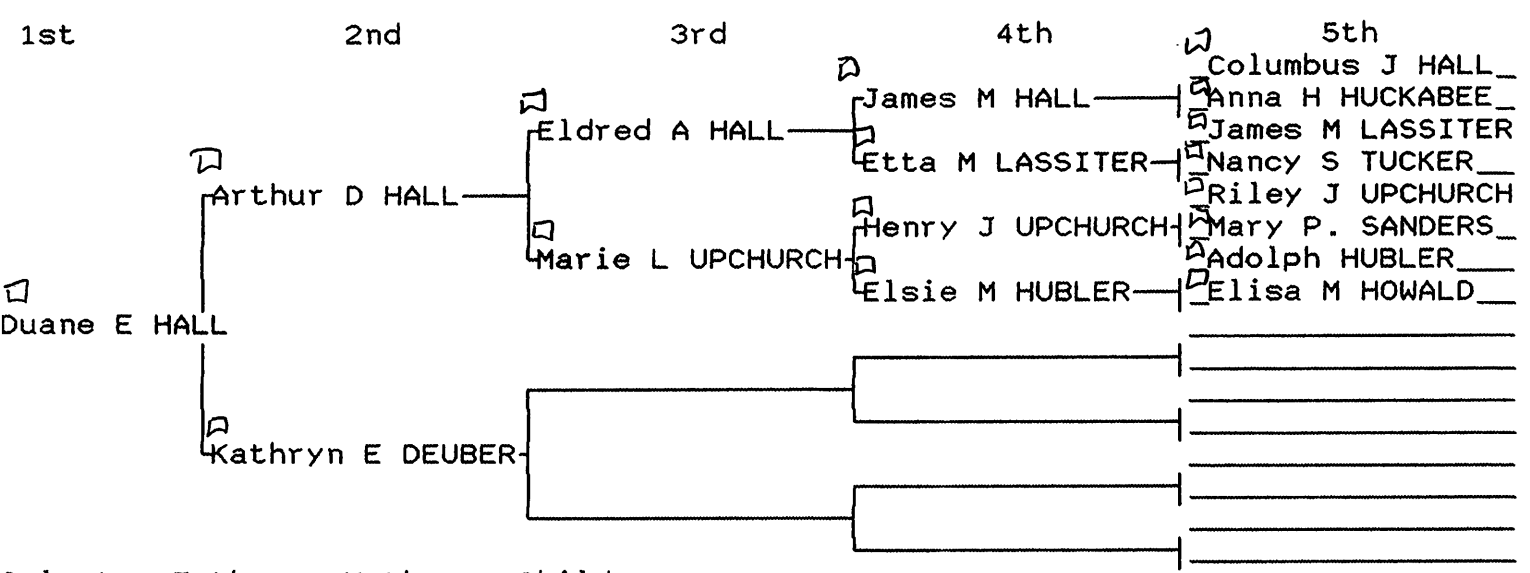

Select: Father Mother Child  
Spouse eXit

△  
Sherri Ann HALL-12  
B: 7 Jan 1972  
M:  
D:  
Madisonville, Madison, Texas

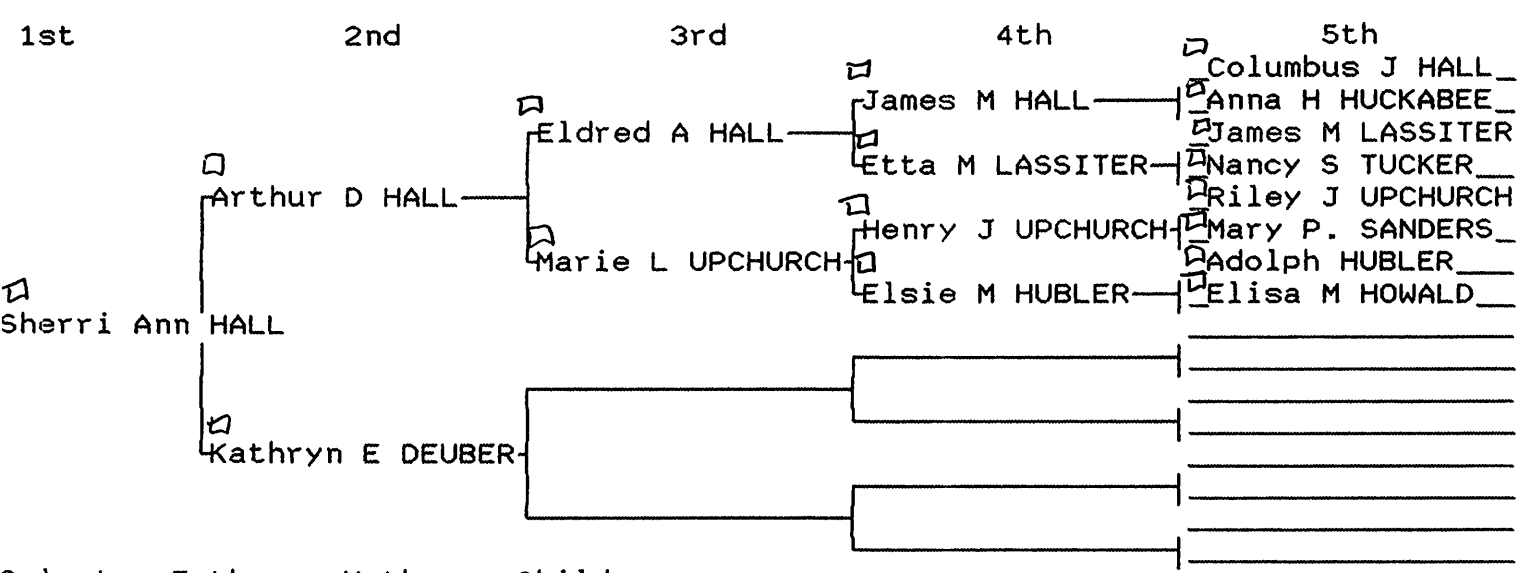

Select: Father Mother Child  
Spouse eXit

△  
Carol WRIGHT-192  
B: 27 Dec 1946  
M: 1976(div) --59  
D:

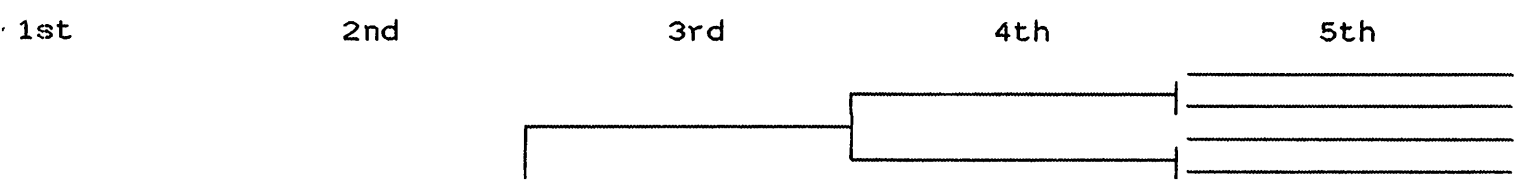

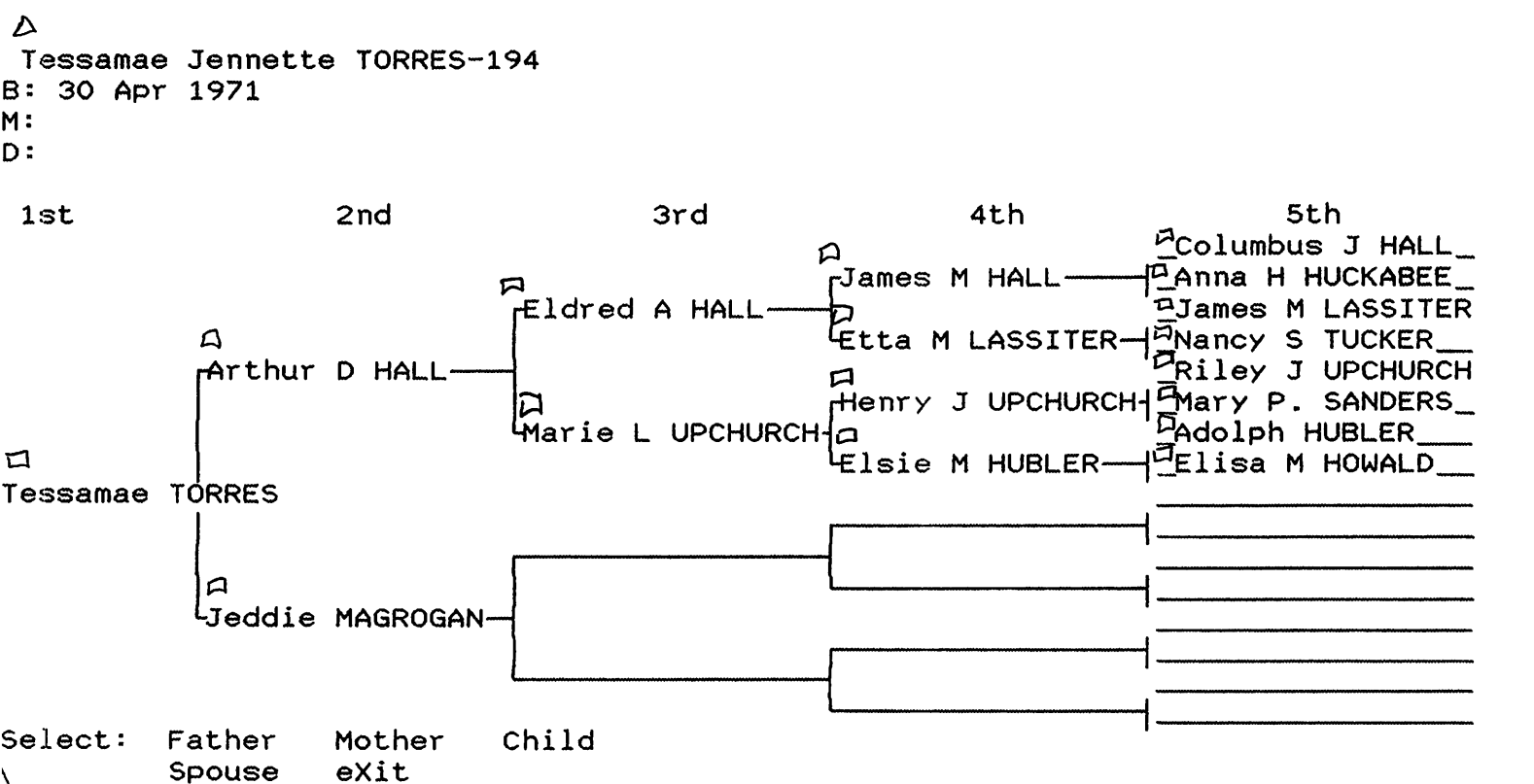
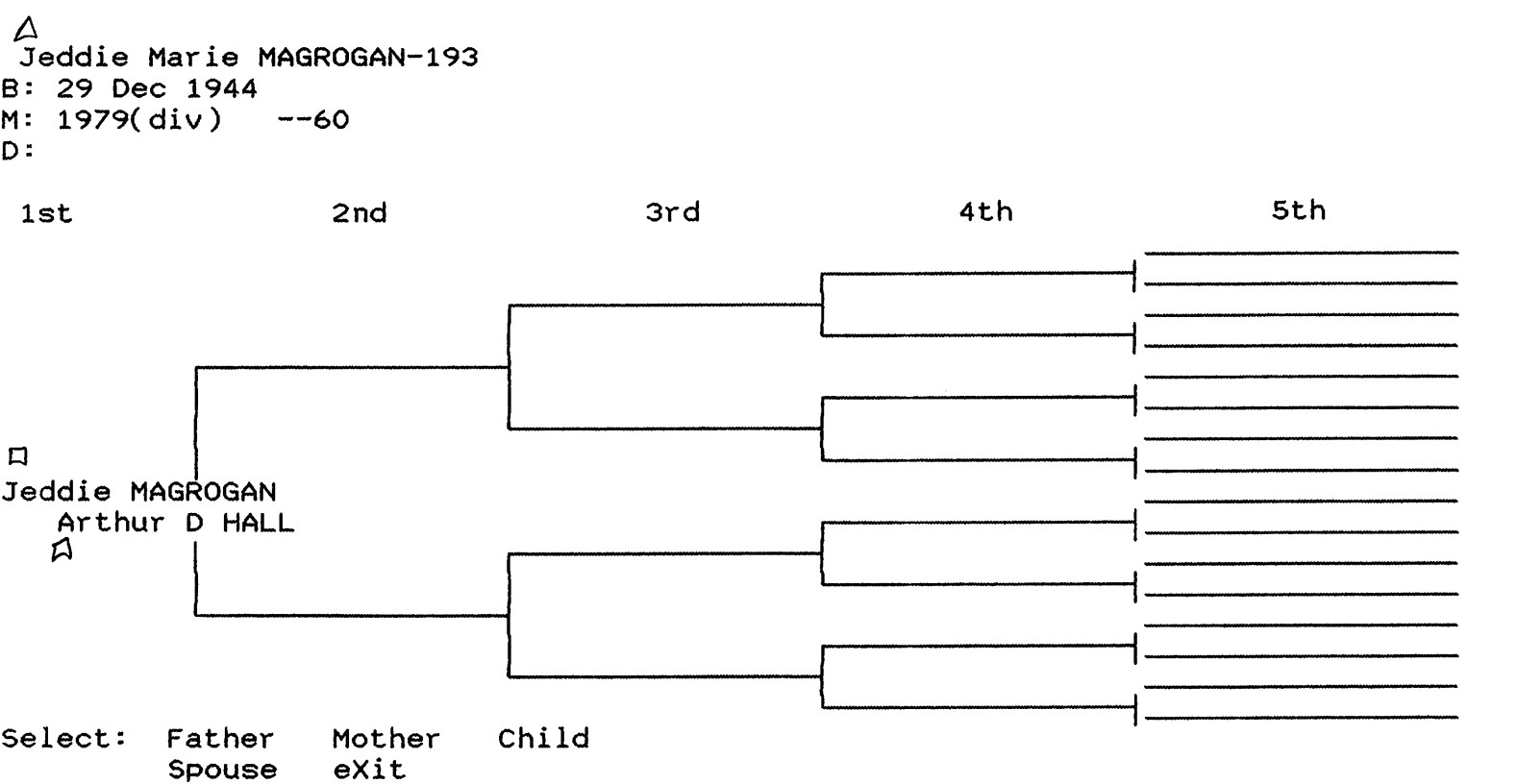
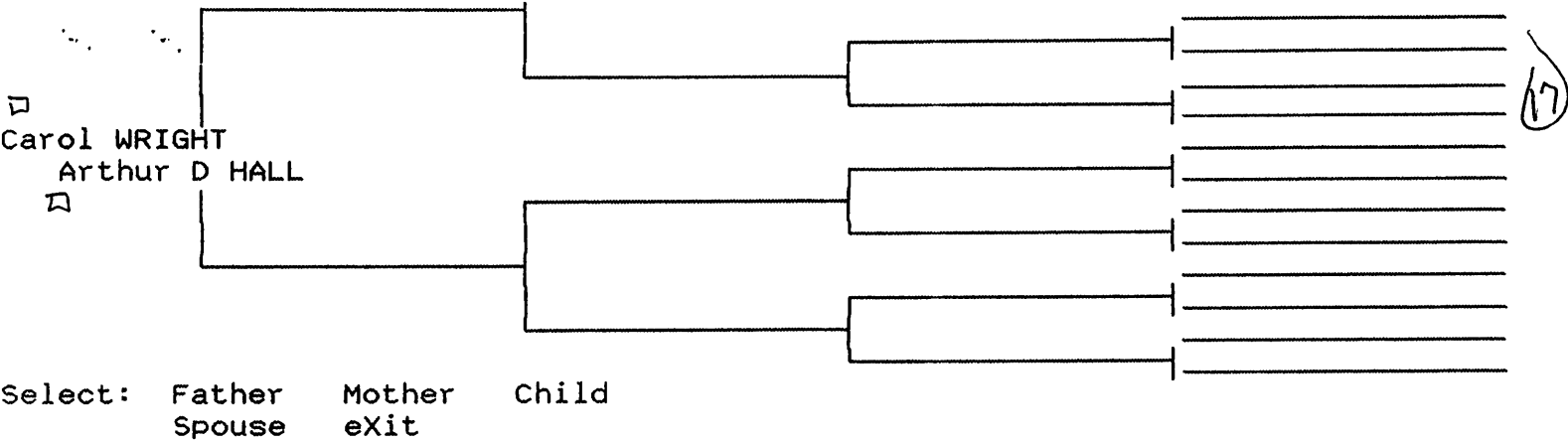





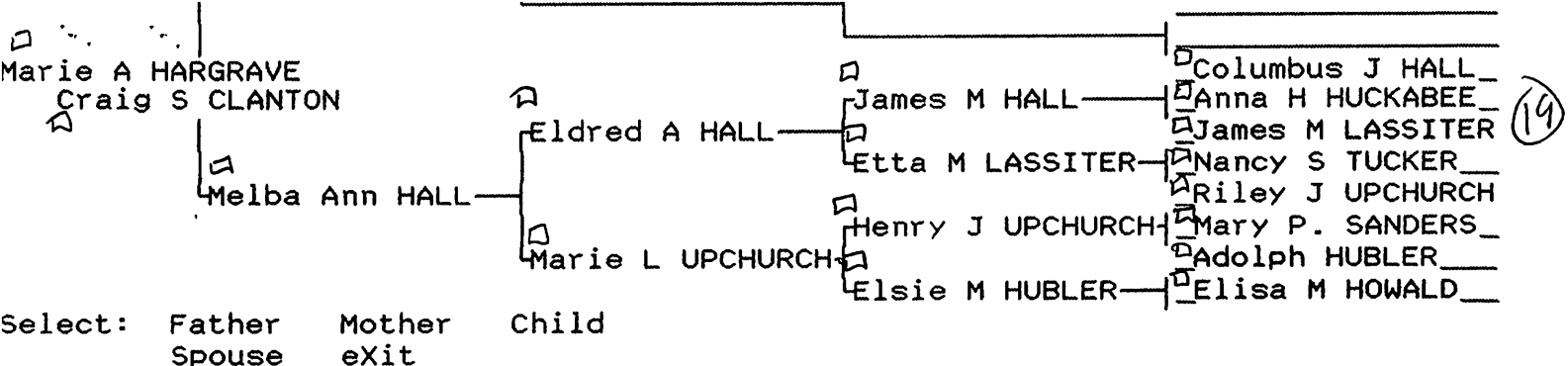

Craig Stephen CLANTON-30  
 B: 24 Sep 1960            Quitman, Wood, Texas  
 M: 4 Dec 1982    --11    Quitman, Wood, Texas  
 D:

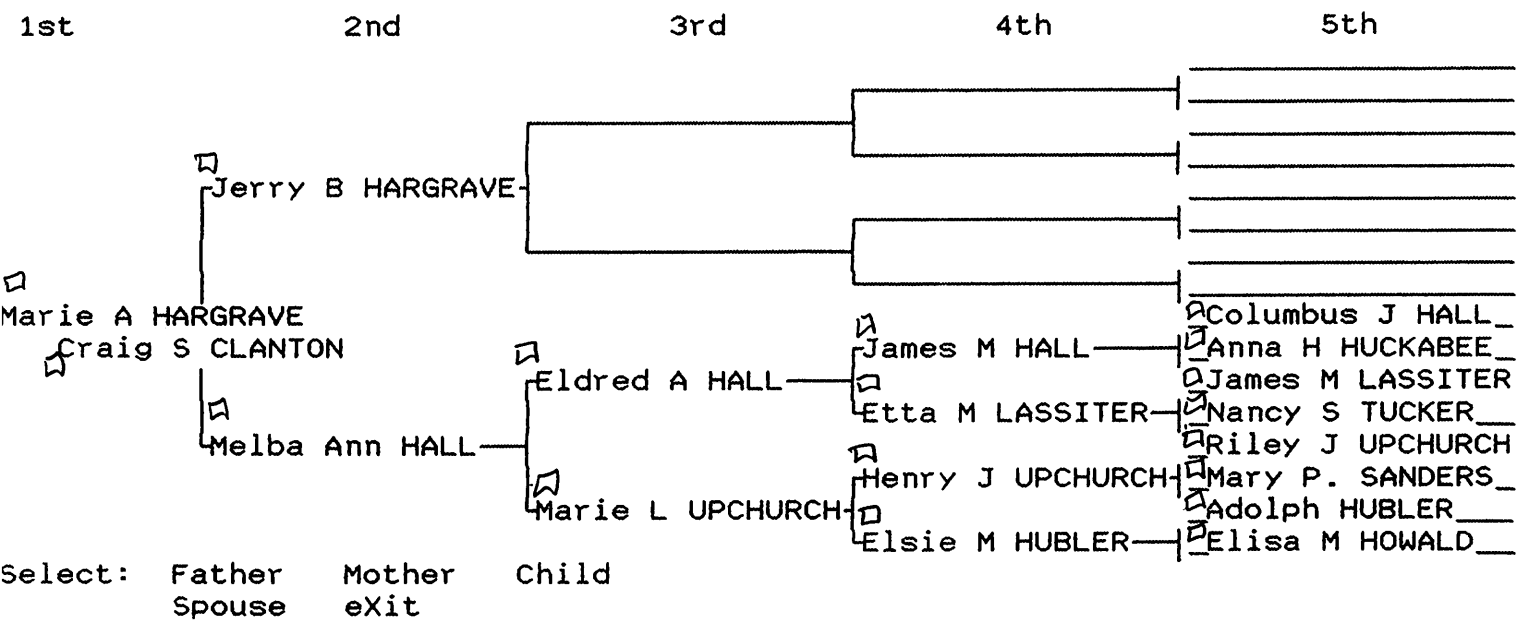

Joshua Aaron CLANTON-31  
 B: 11 Feb 1989            Sulphur Springs, Texas  
 M:  
 D:

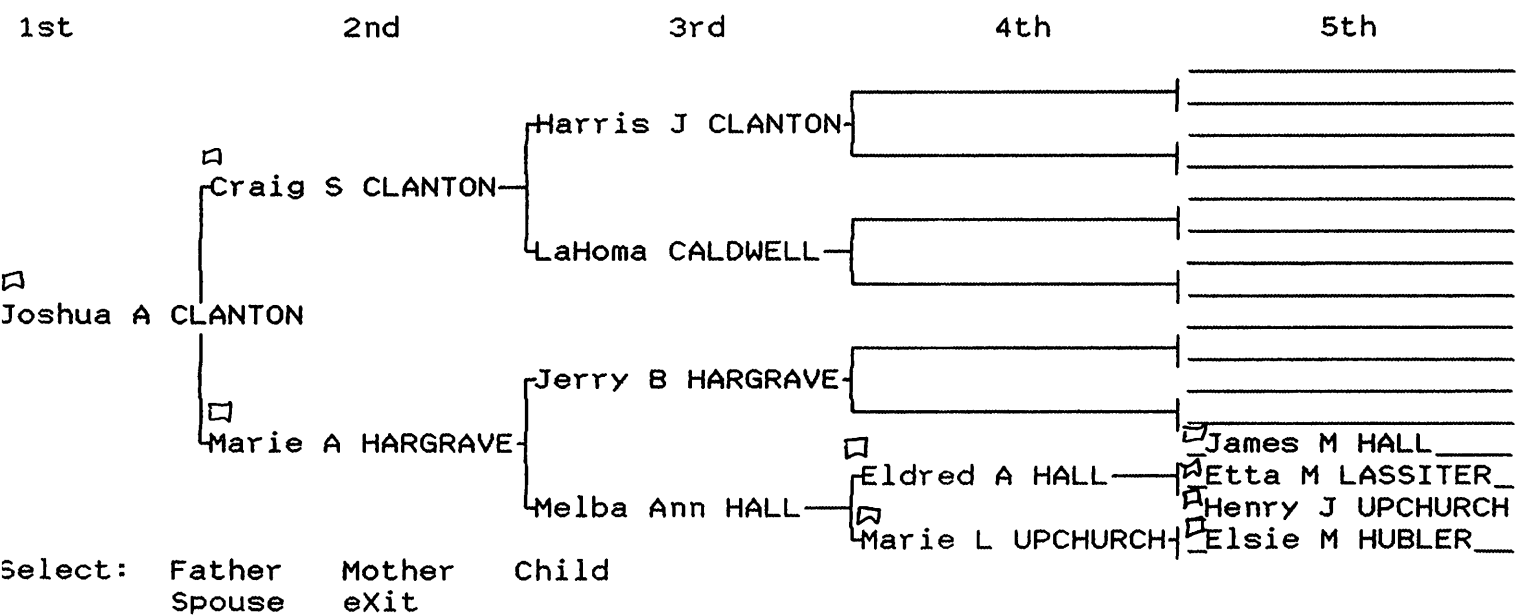



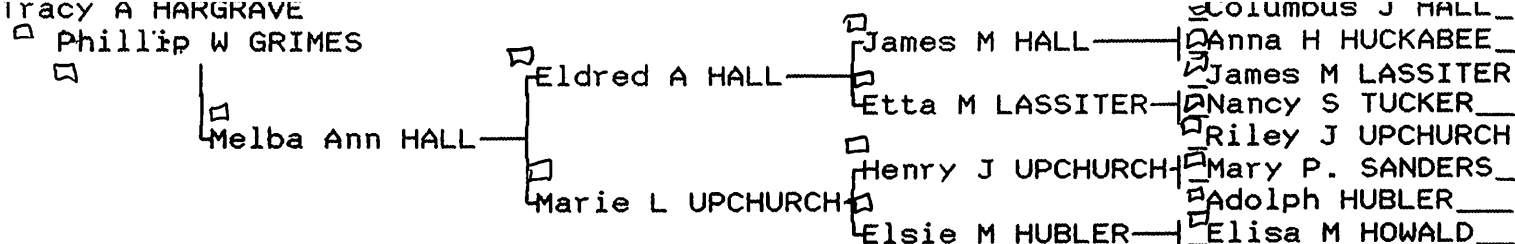

Select: Father Spouse Mother eXit Child

Kelly Dean ACKER-34  
 B: 3 Mar 1967 Tyler,Smith,Texas  
 M: 31 Dec 1990 --13 Chapel Hill,Smith,Texas  
 D:

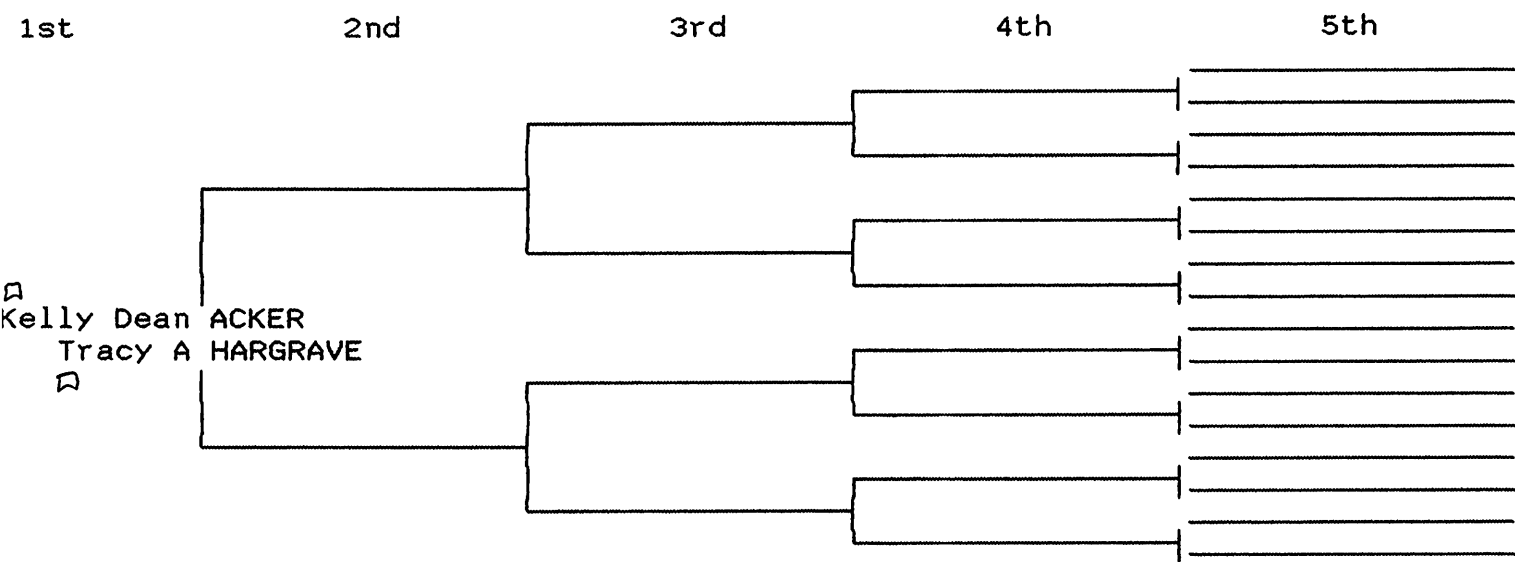

Select: Father Spouse Mother eXit Child

Raymond Leo HALL-9  
 B: 17 Nov 1944 Houston,Harris,Texas  
 M:  
 D:

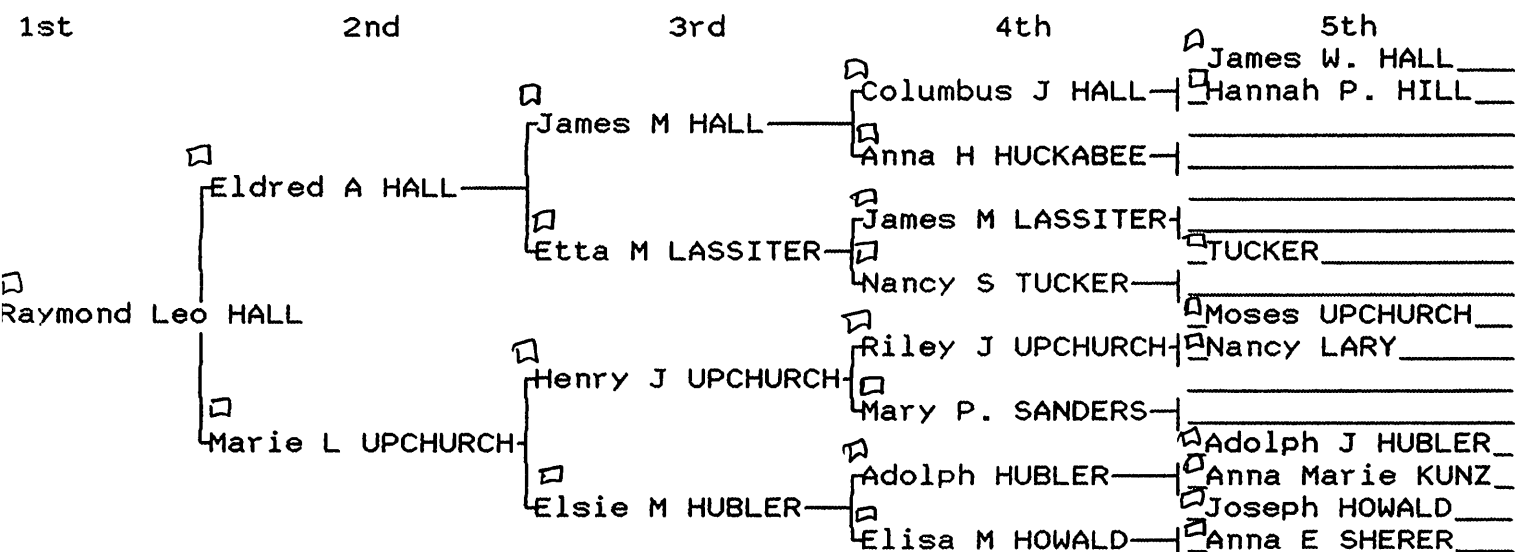

Select: Father Spouse Mother eXit Child

Betty Margaret HALL-2  
 B: 28 Nov 1945 West Columbia,Brazoria,Texas

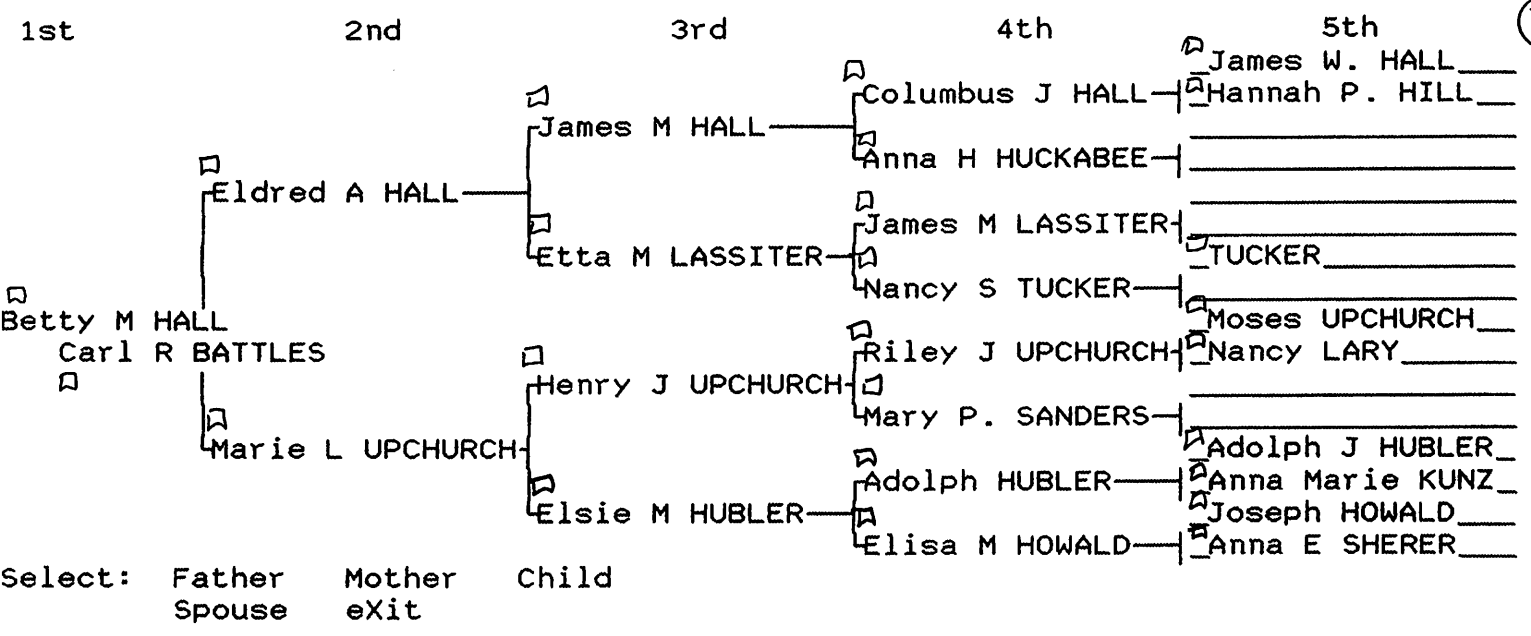

△  
 Carl Richard BATTLES-1  
 B: 12 Jan 1940 Akron, Summit, Ohio  
 M: 16 Dec 1967 --1 Richmond, Fort Bend Co, Texas  
 D:

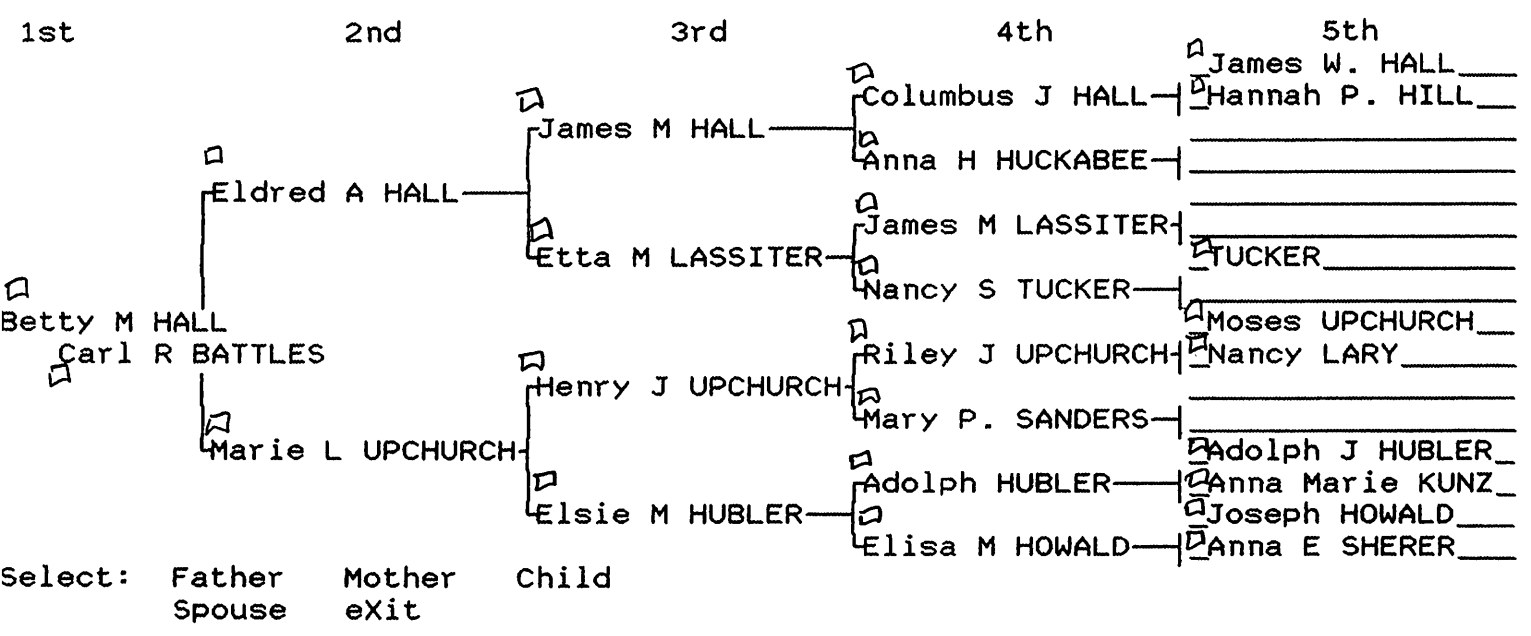

△  
 Margie Lee URBAN-312  
 B:  
 M: --110  
 D:

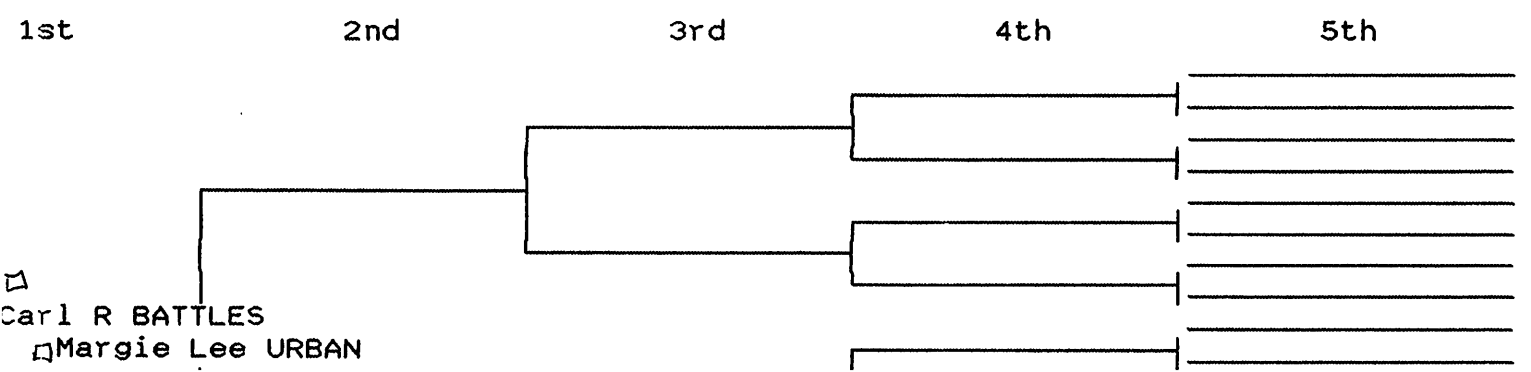

Select: Father Mother Child  
Spouse eXit

△  
Cynthia Ann BATTLES-313  
B: 18 Aug 1966 Houston,Harris,Texas  
M: --111  
D:

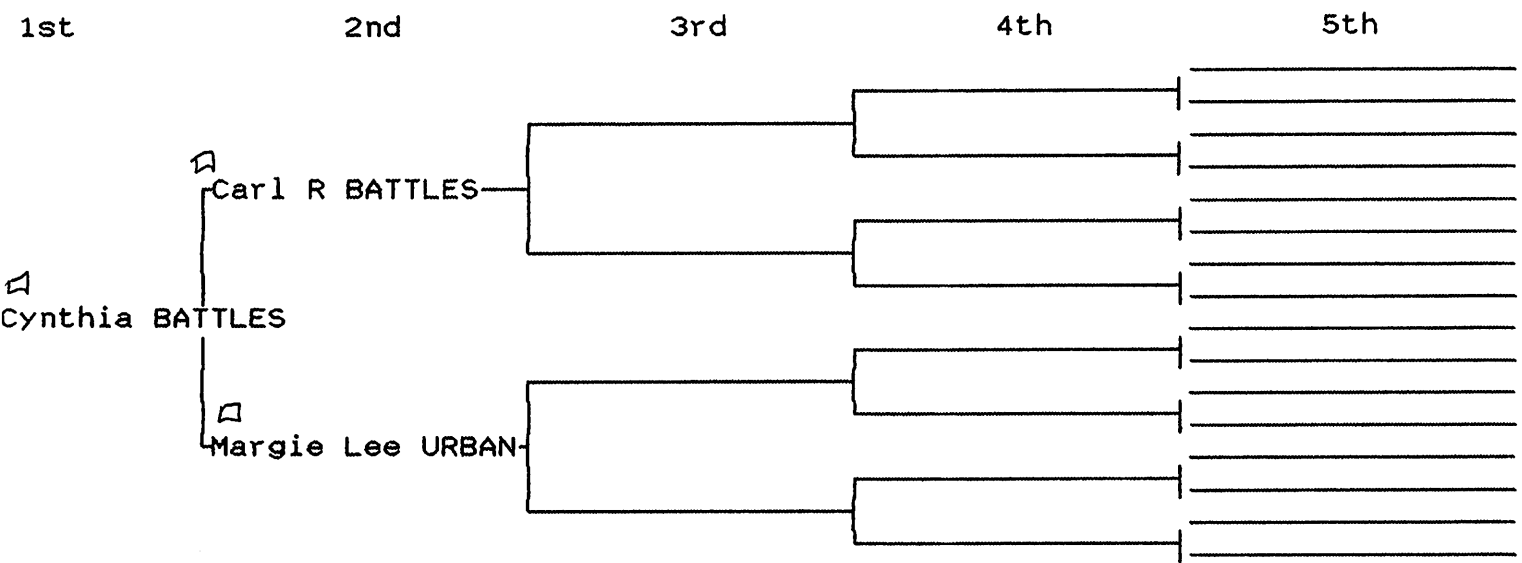

Select: Father Mother Child  
Spouse eXit

△  
Richard Andrew BATTLES-3  
B: 7 Jun 1968 Houston,Harris,Texas  
M:  
D:

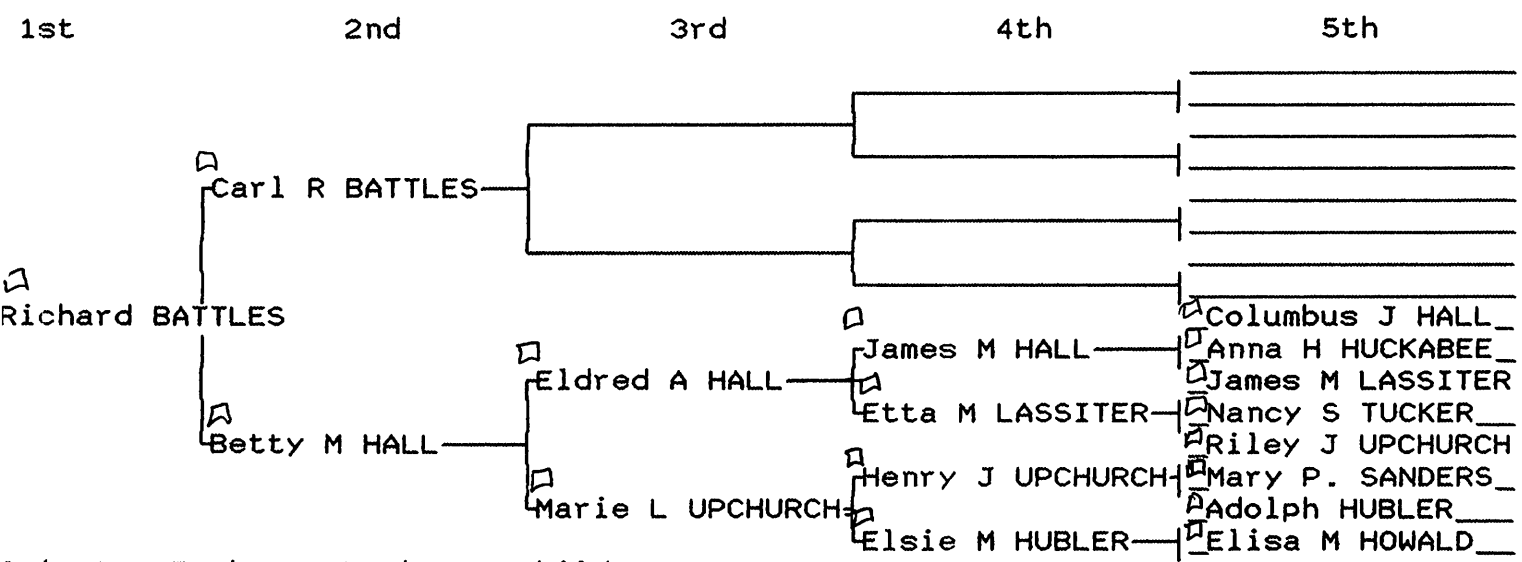

Select: Father Mother Child  
Spouse eXit

△  
James Alan BATTLES-4  
B: 15 Jun 1972 Houston,Harris,Texas  
M:  
D:



Select: Father Mother Child  
Spouse eXit

Elizabeth Lynette UPCHURCH-196  
B: 13 Feb 1958 Houston,Harris,Texas  
M: 1974(div) --62  
D:

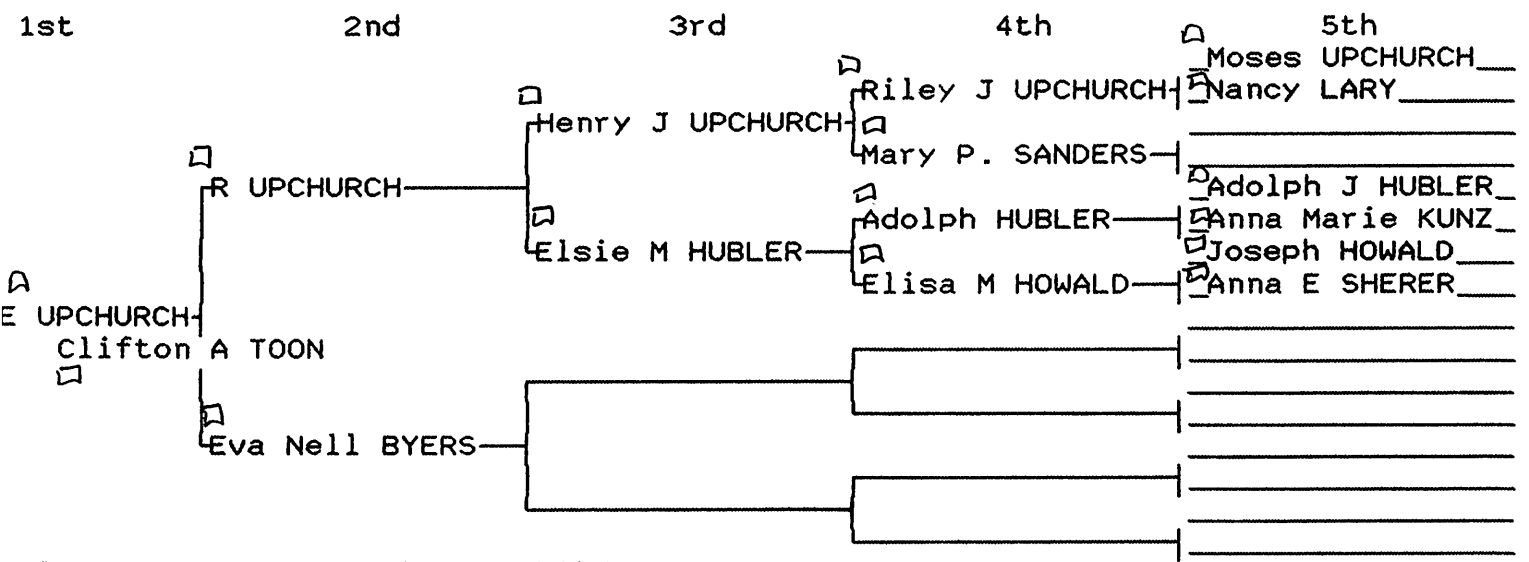

Select: Father Mother Child  
Spouse eXit

Clifton Andrew TOON-198  
B:  
M: 1974(div) --62  
D:

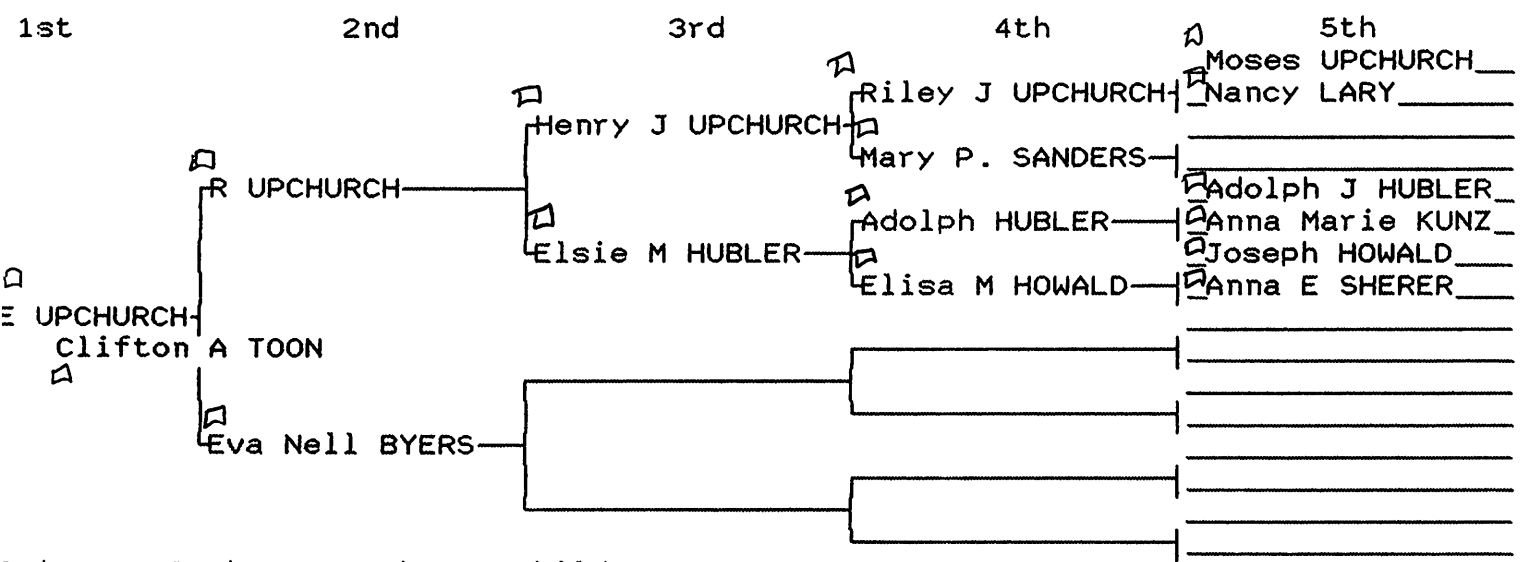

Select: Father Mother Child  
Spouse eXit

Clifton Aaron TOON-199  
B: 12 Feb 1975  
M:  
D:

1st 2nd 3rd 4th 5th



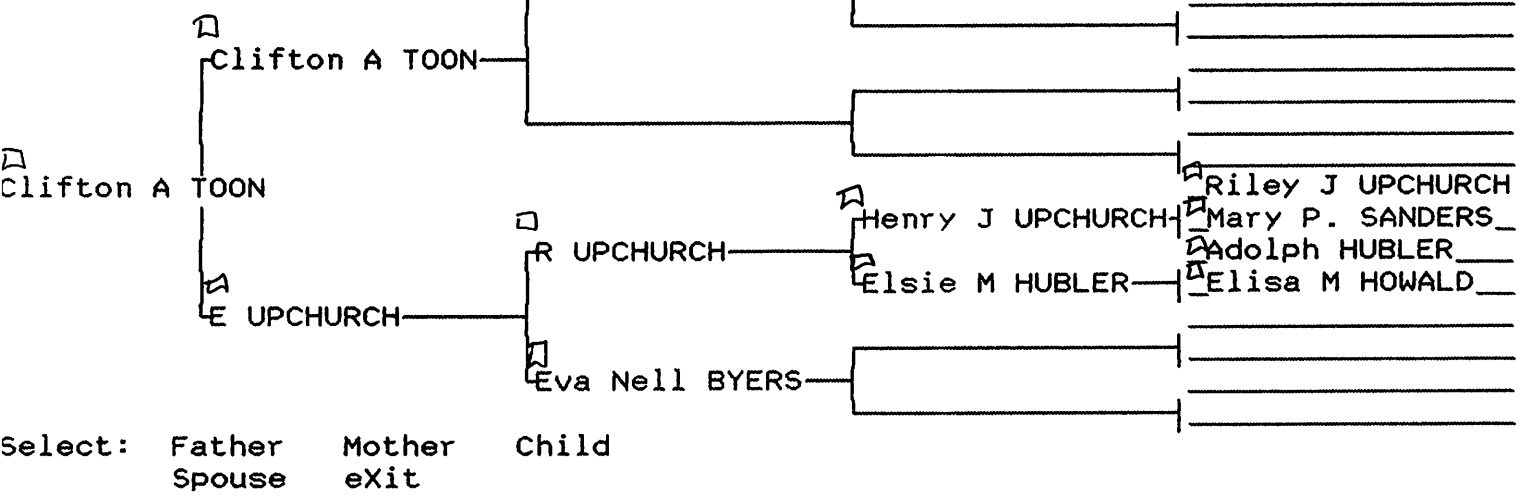

Cinnamon Candice TOON-200  
 B: 30 Aug 1977  
 M:  
 D:

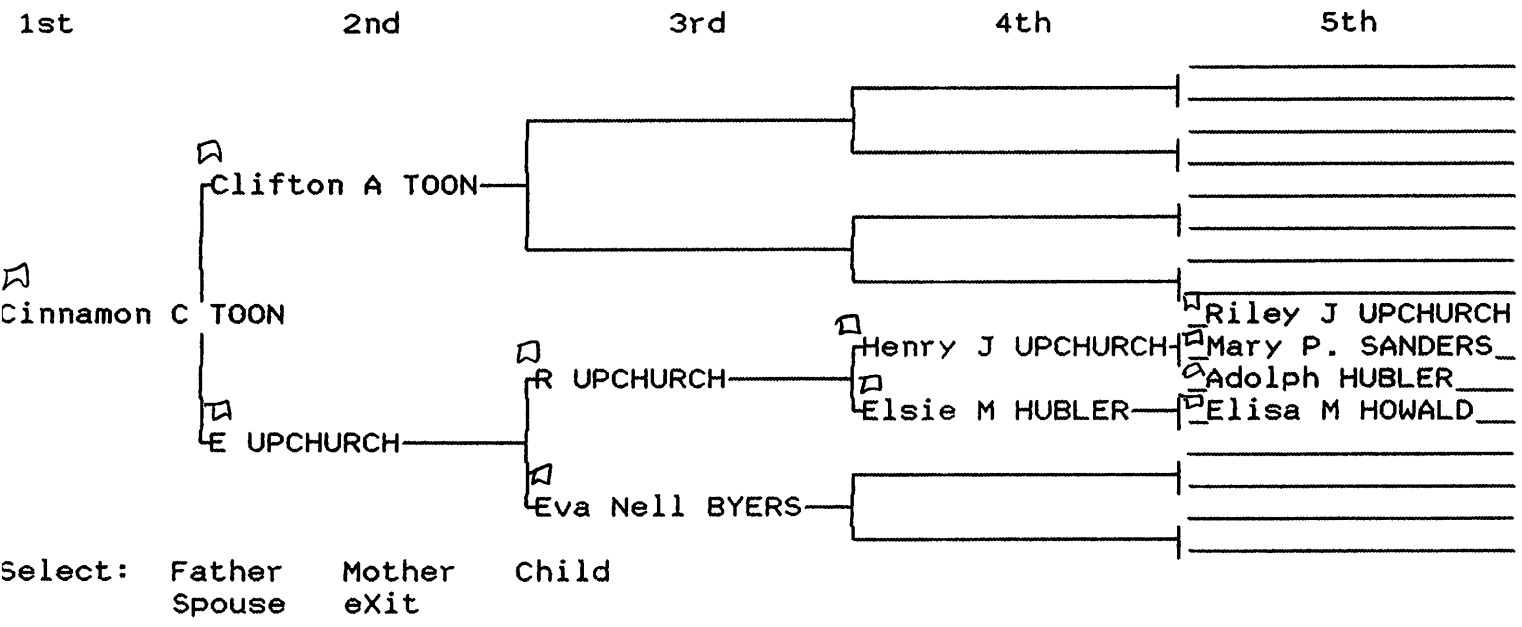

Ronnie .....-201  
 B:  
 M:  
 D:

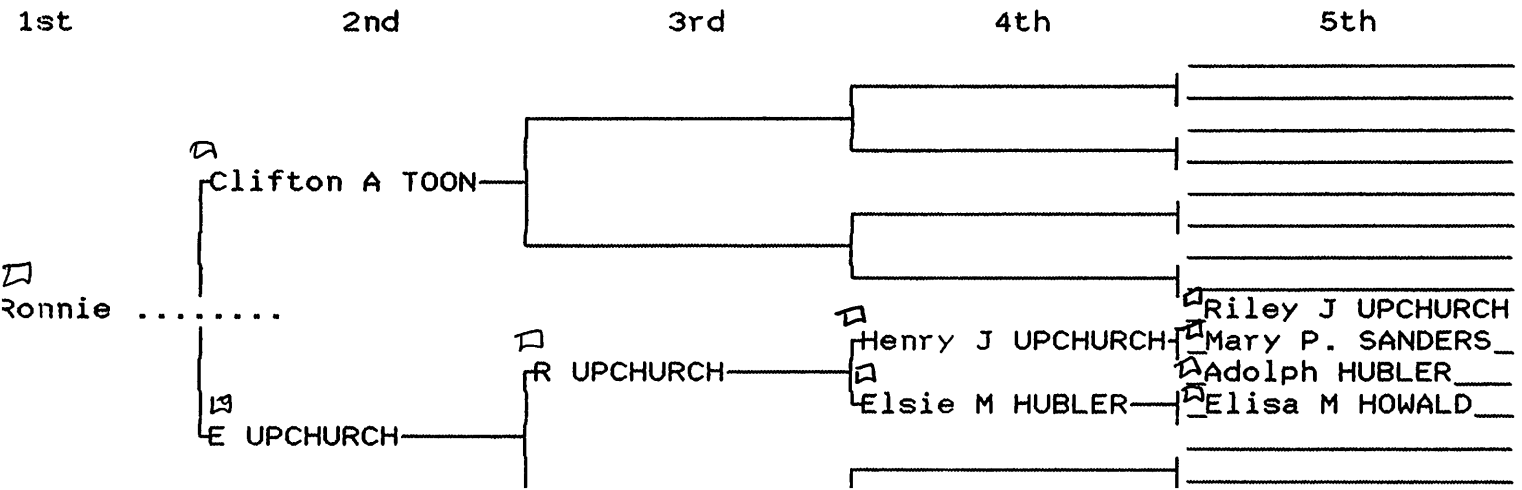

Eva Nell BYERS

Select: Father Spouse Mother eXit Child

Keys BORDVINE-202  
 B: 8 Dec 1945  
 M: 2 May 1987 --63  
 D:

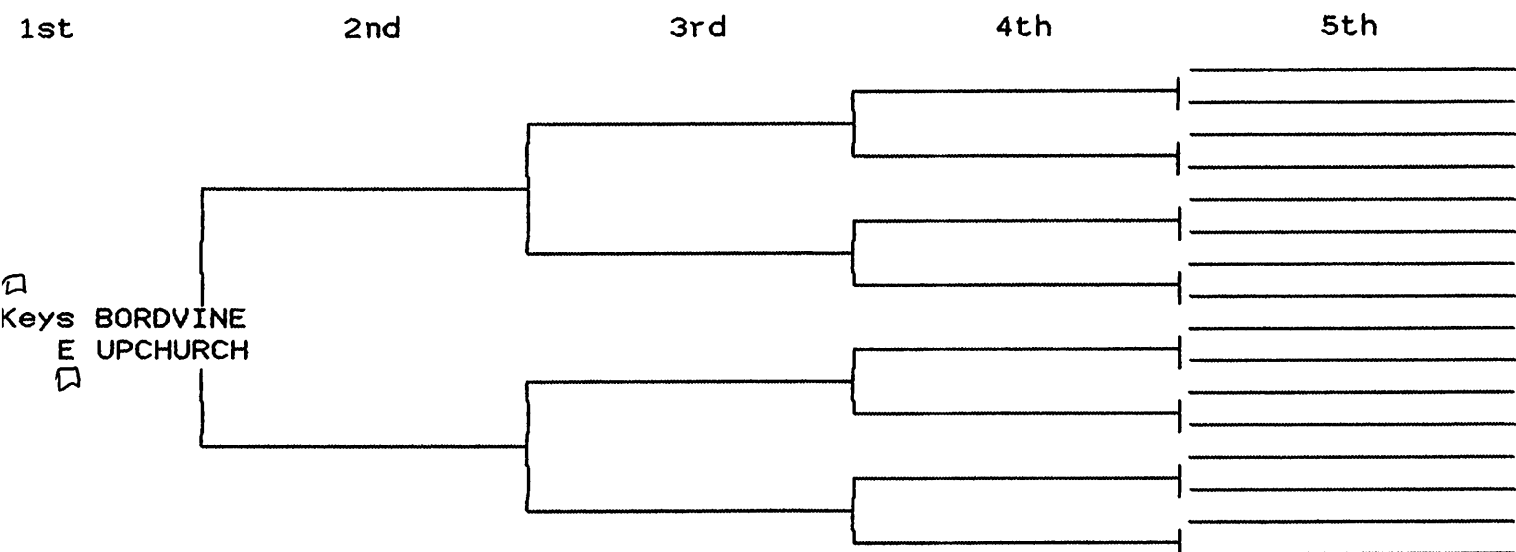

Select: Father Spouse Mother eXit Child

Leslie Ray UPCHURCH-197  
 B: 15 Sep 1959  
 M:  
 D:

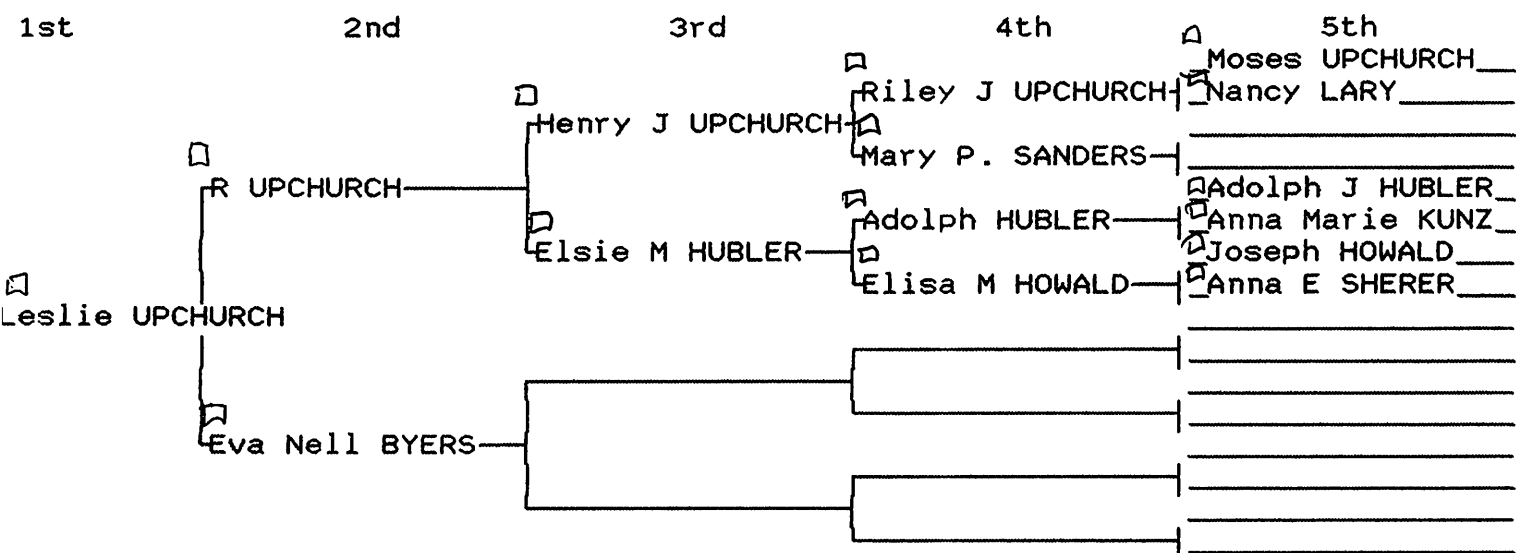

Select: Father Spouse Mother eXit Child

Dorothea Myerle UPCHURCH-173  
 B: 29 Nov 1923                      Bedias, Grimes, Texas  
 M: --64  
 D:



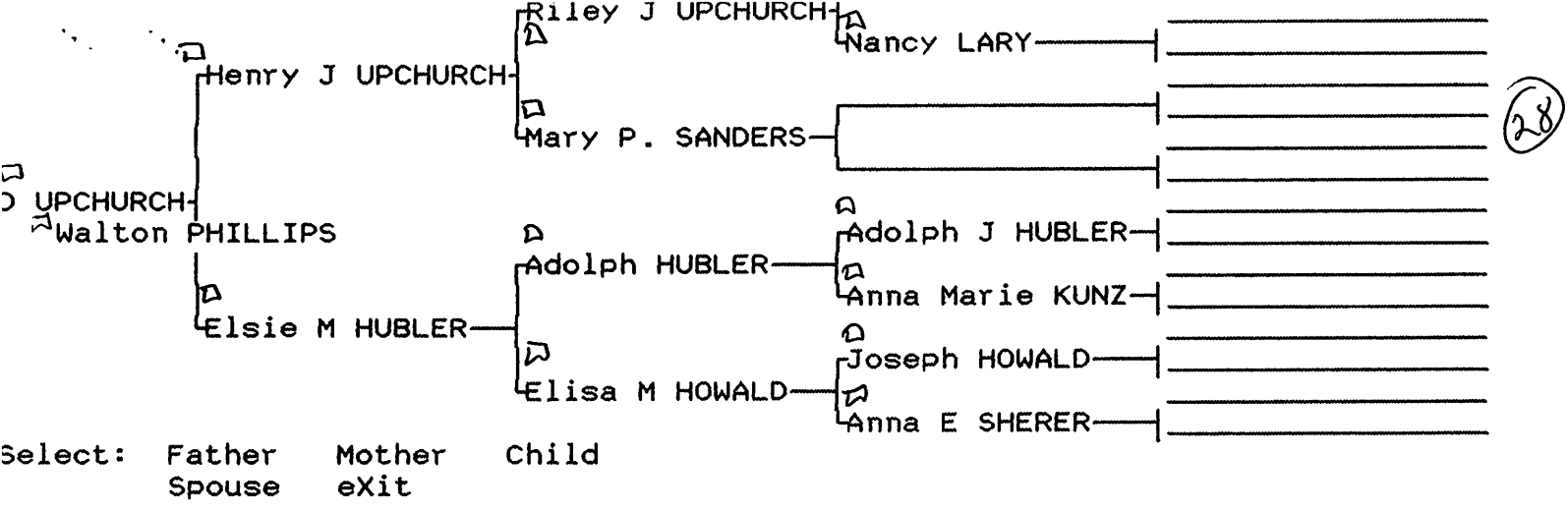

Walton Buzzell PHILLIPS-203  
 B: 11 Aug 1920  
 M: --64  
 D:

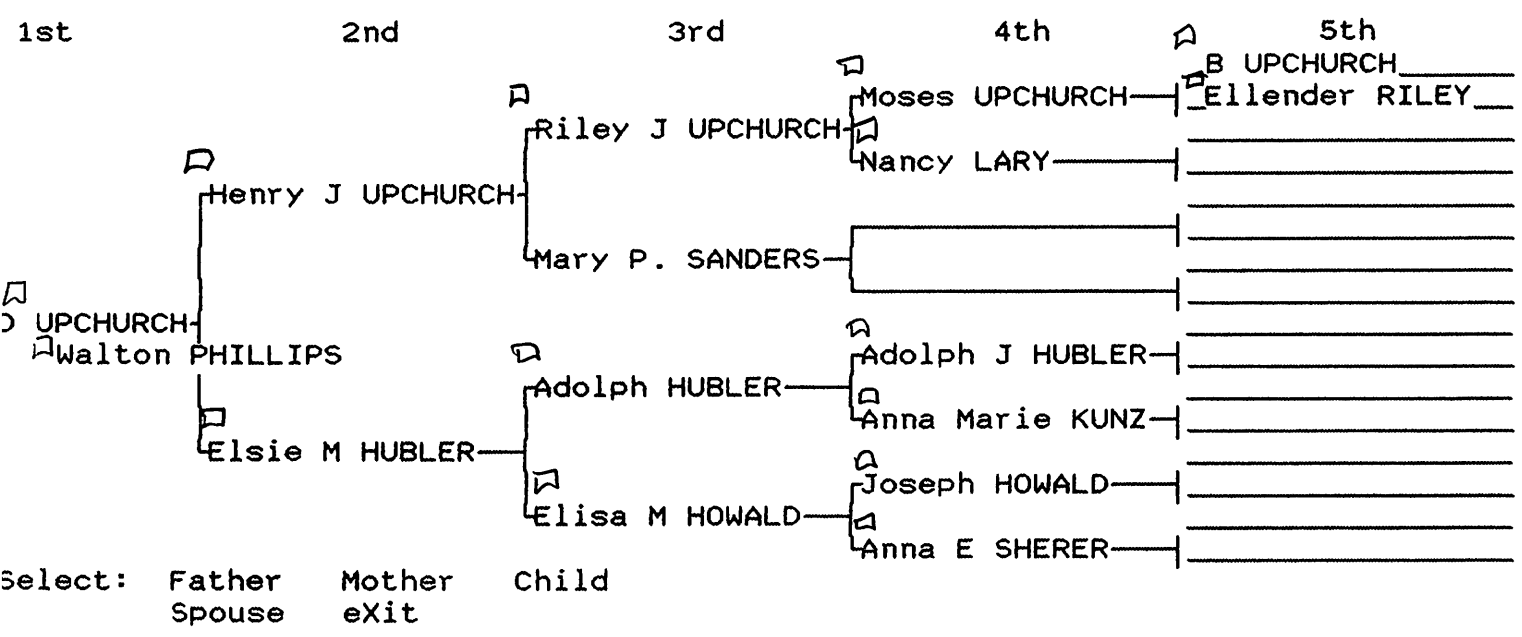

Charles Eddie PHILLIPS-204  
 B: 15 Jan 1947  
 M: 27 Jan 1973    --65    Houston, Harris, Texas  
 D:

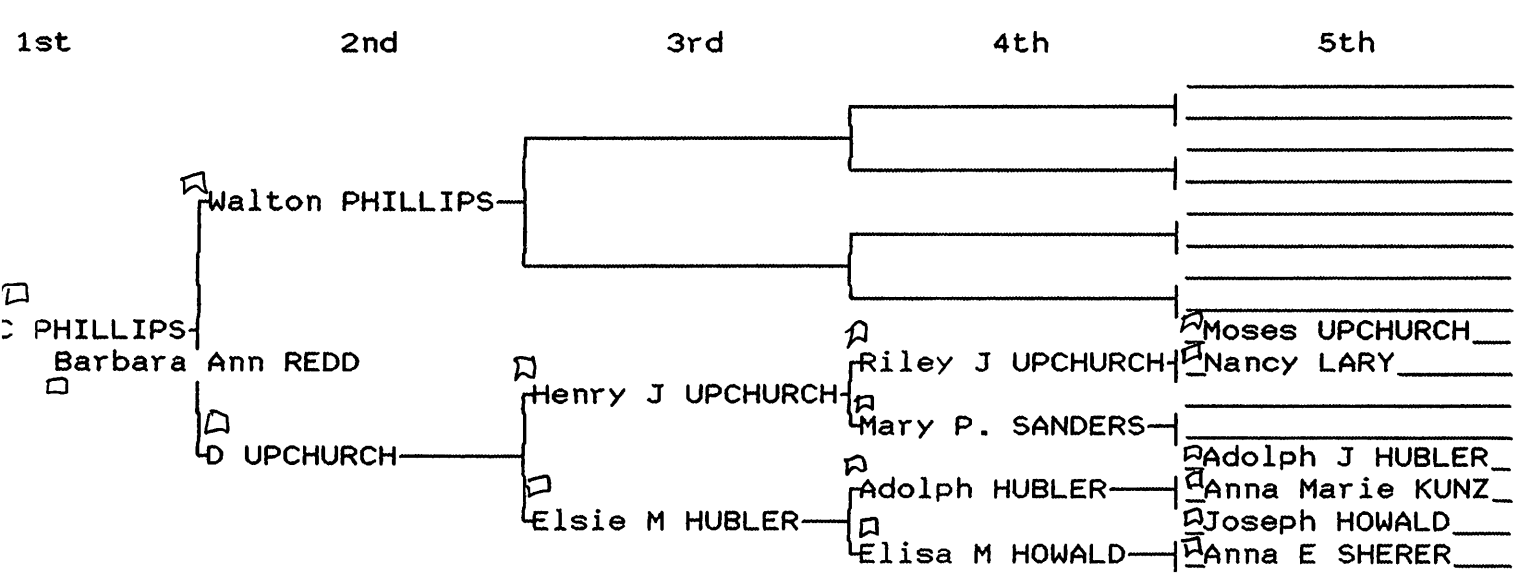

Select: Father Mother Child  
Spouse eXit

29

△  
Barbara Ann REDD-207  
B: 21 Oct 1949  
M: 27 Jan 1973 --65 Houston,Harris,Texas  
D:

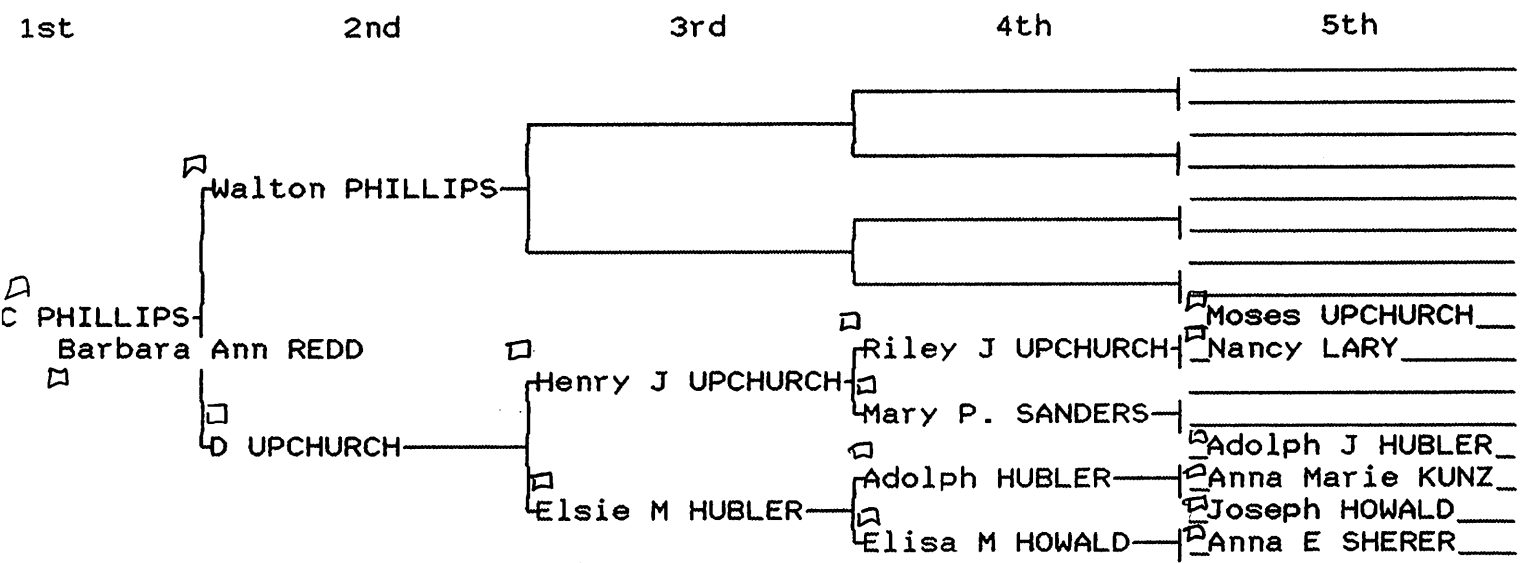

Select: Father Mother Child  
Spouse eXit

△  
David Wayne PHILLIPS-208  
B: 4 Mar 1974 Houston,Harris,Texas  
M:  
D:

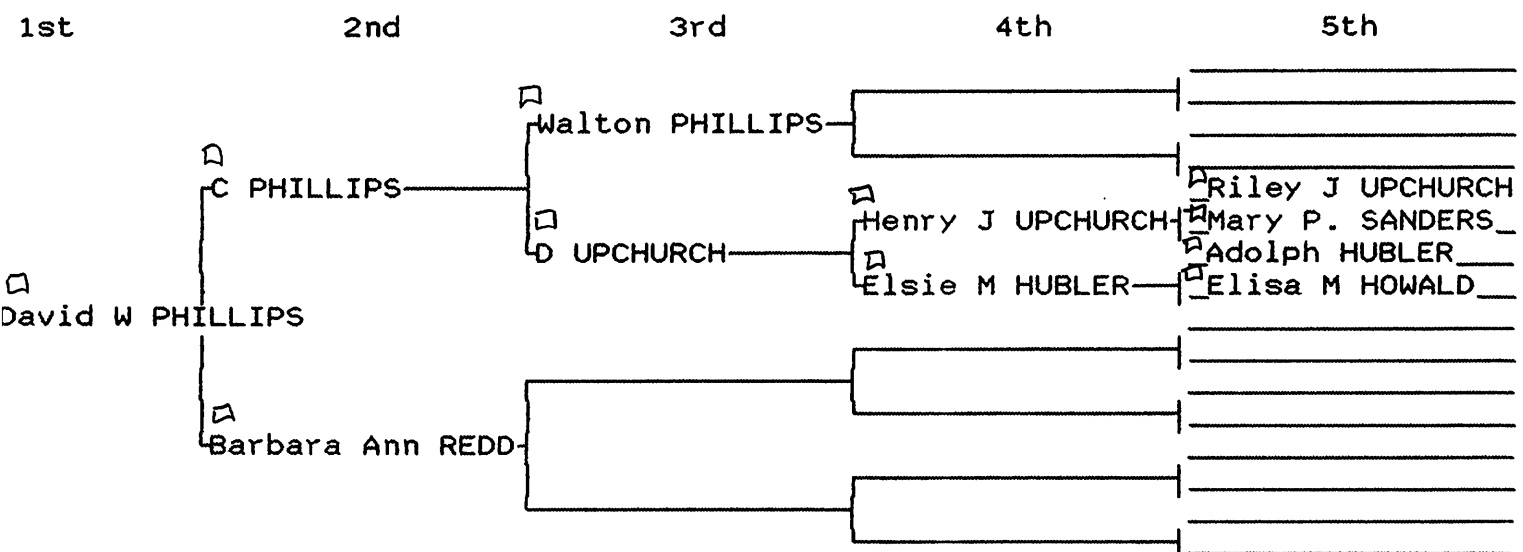

Select: Father Mother Child  
Spouse eXit

△  
Alison Marie PHILLIPS-209  
B: 26 May 1979 Houston,Harris,Texas  
M:  
D:

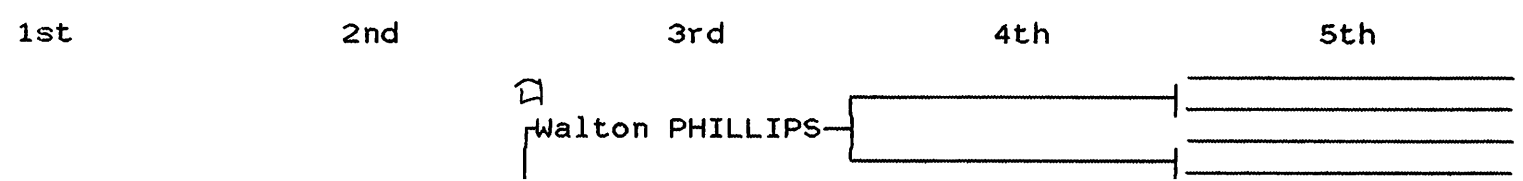

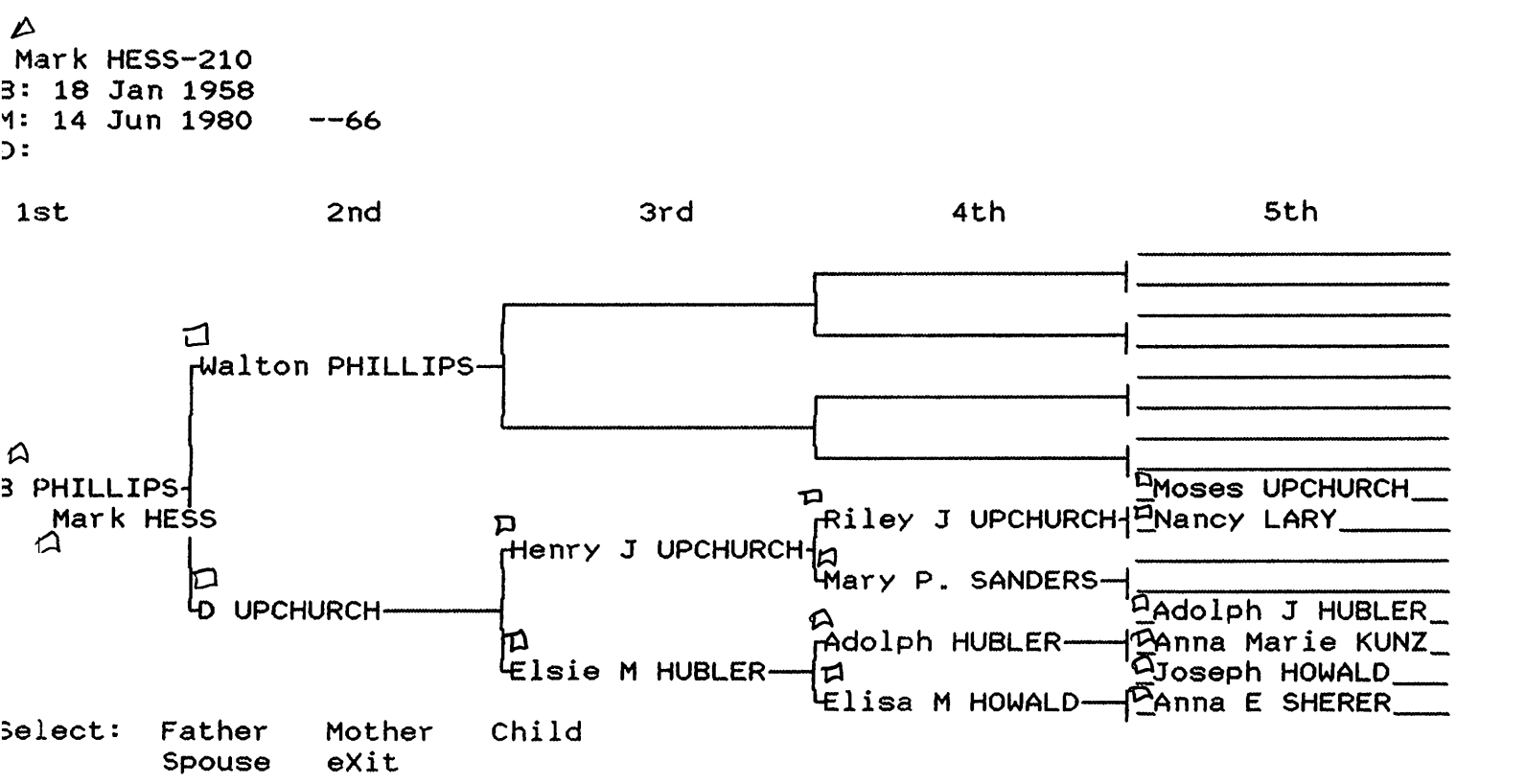
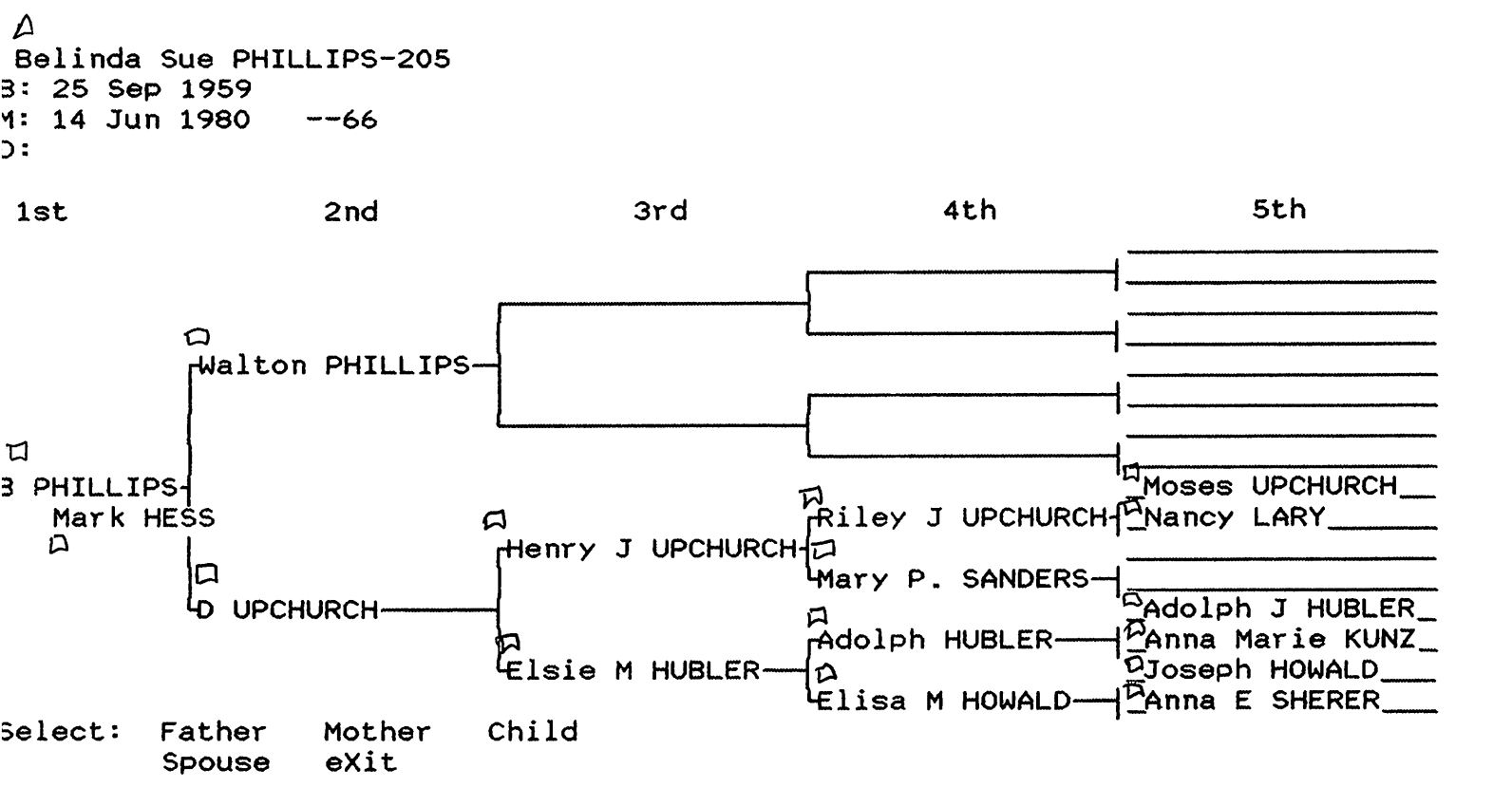
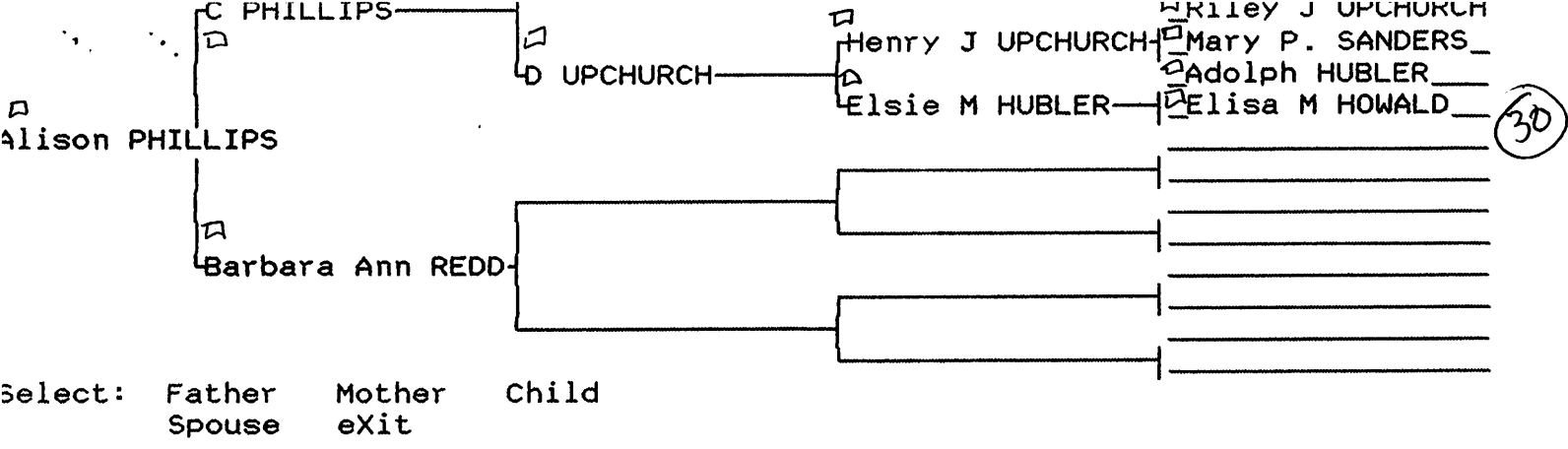



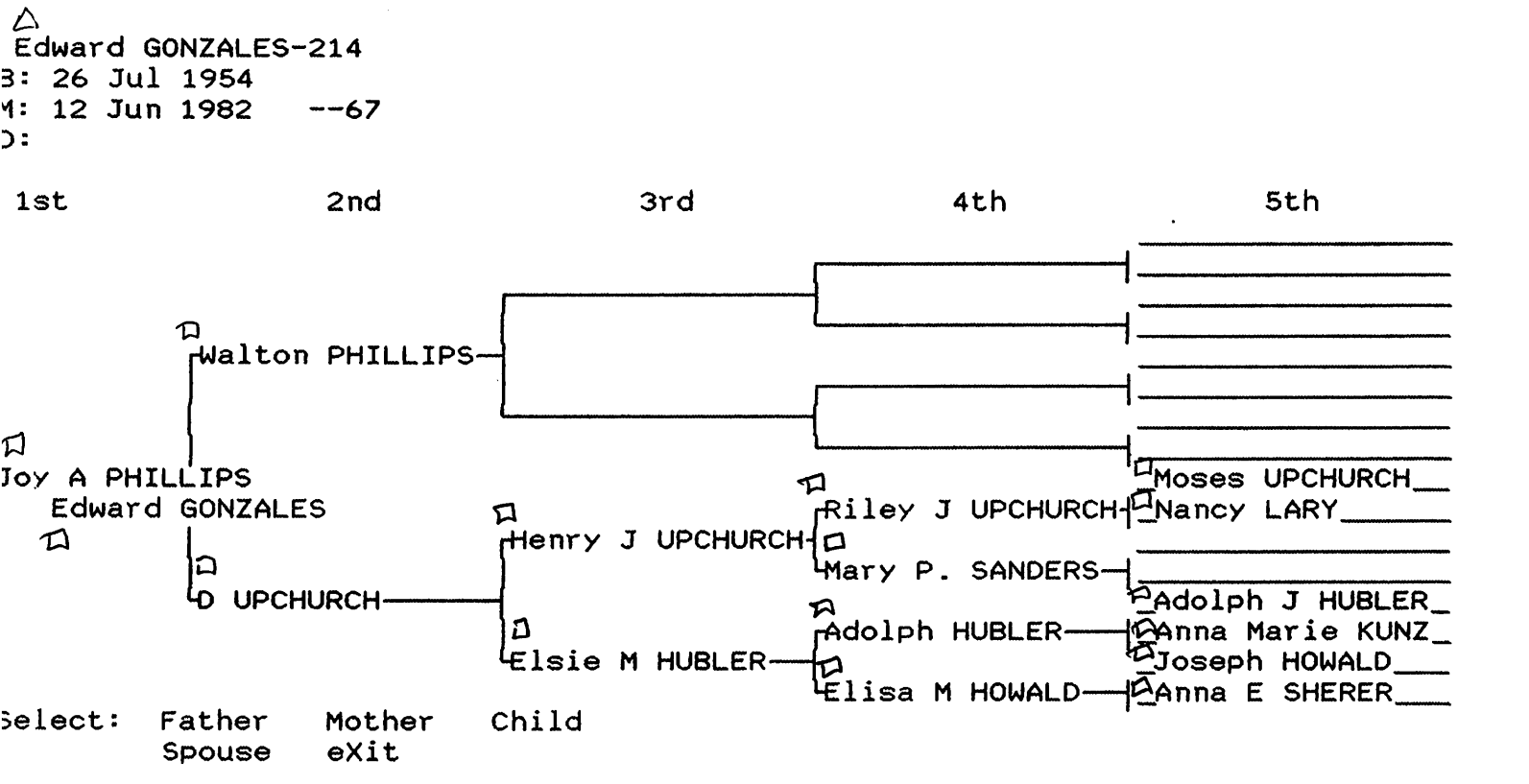
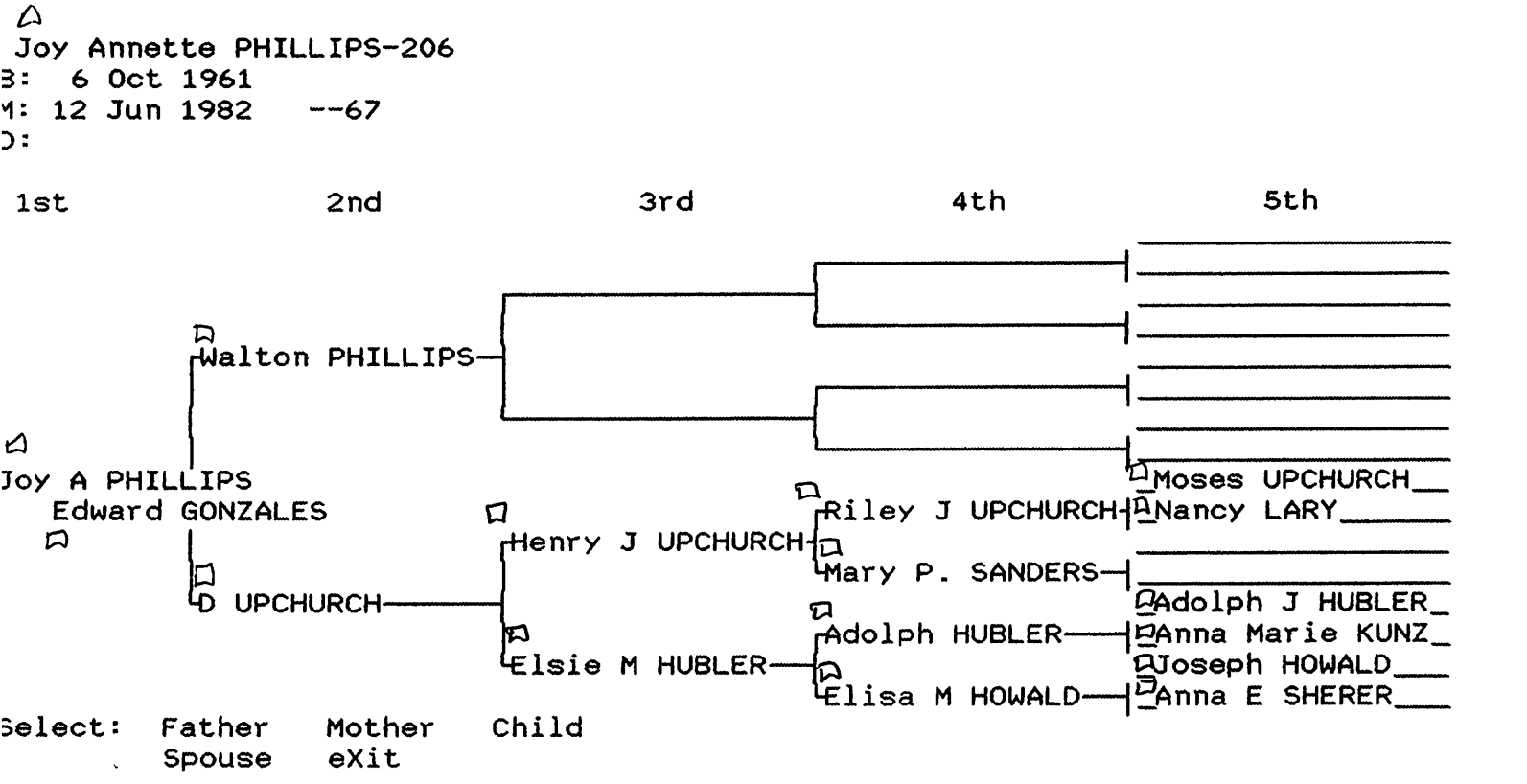
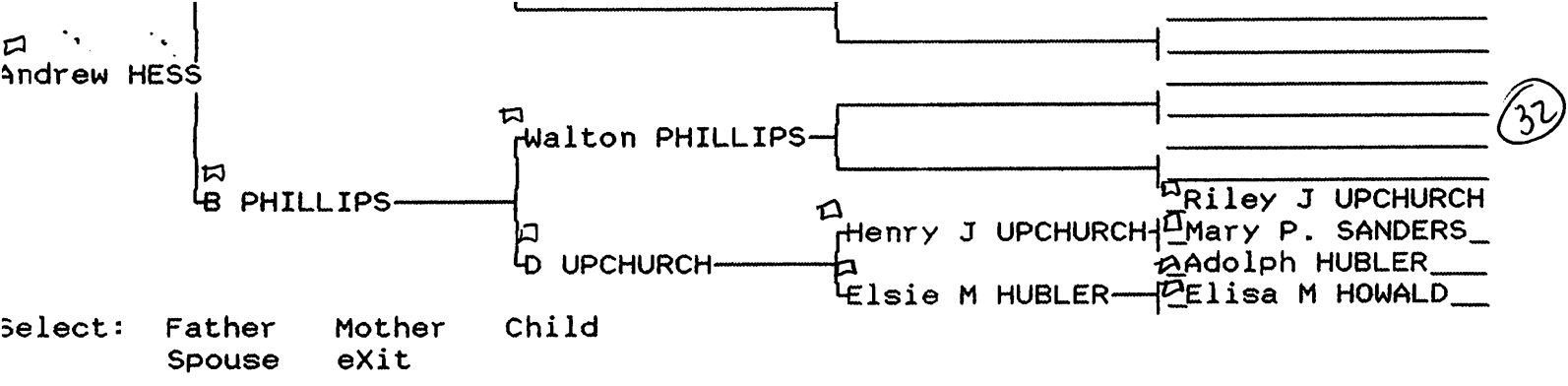

▲ Tiamo Santeago GONZALES-215  
 B: 26 Oct, 1985  
 M:  
 D:

(33)

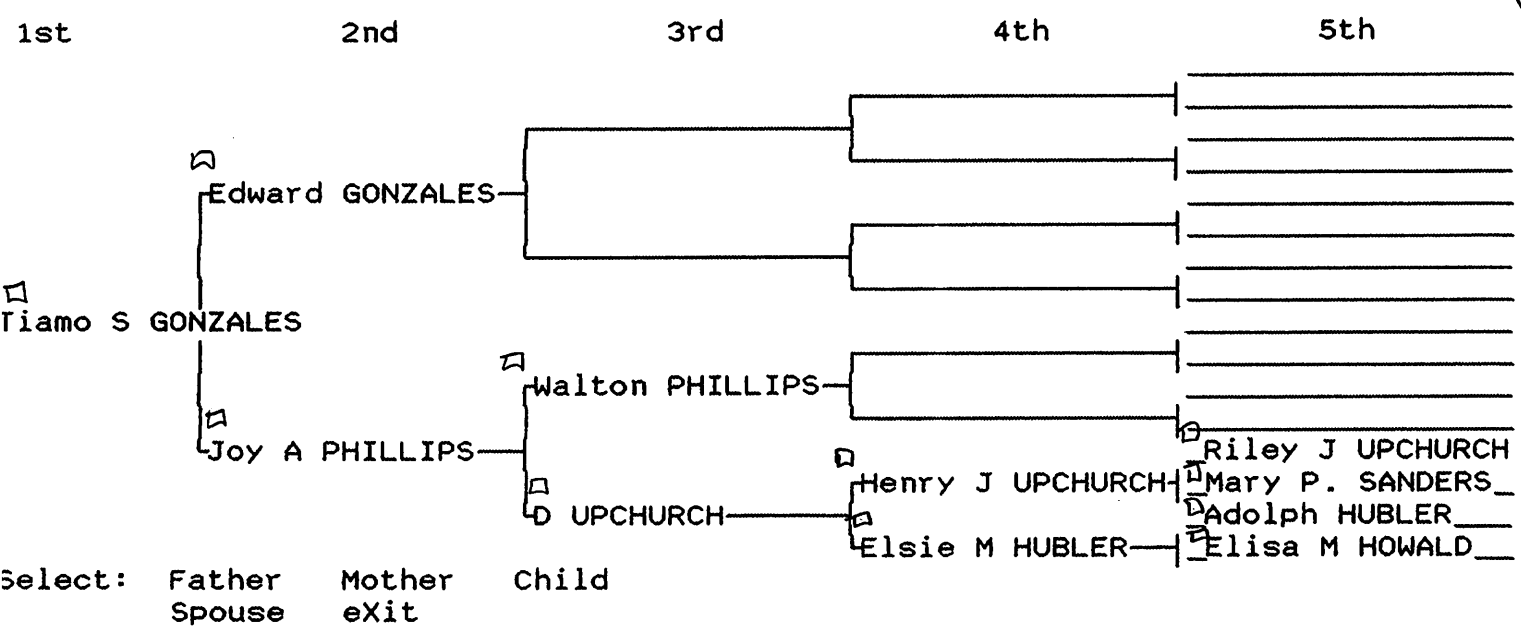

▲ Charles Henry UPCHURCH-174  
 B: 17 May 1927 Bedias, Grimes, Texas  
 M: (div) --68  
 D:

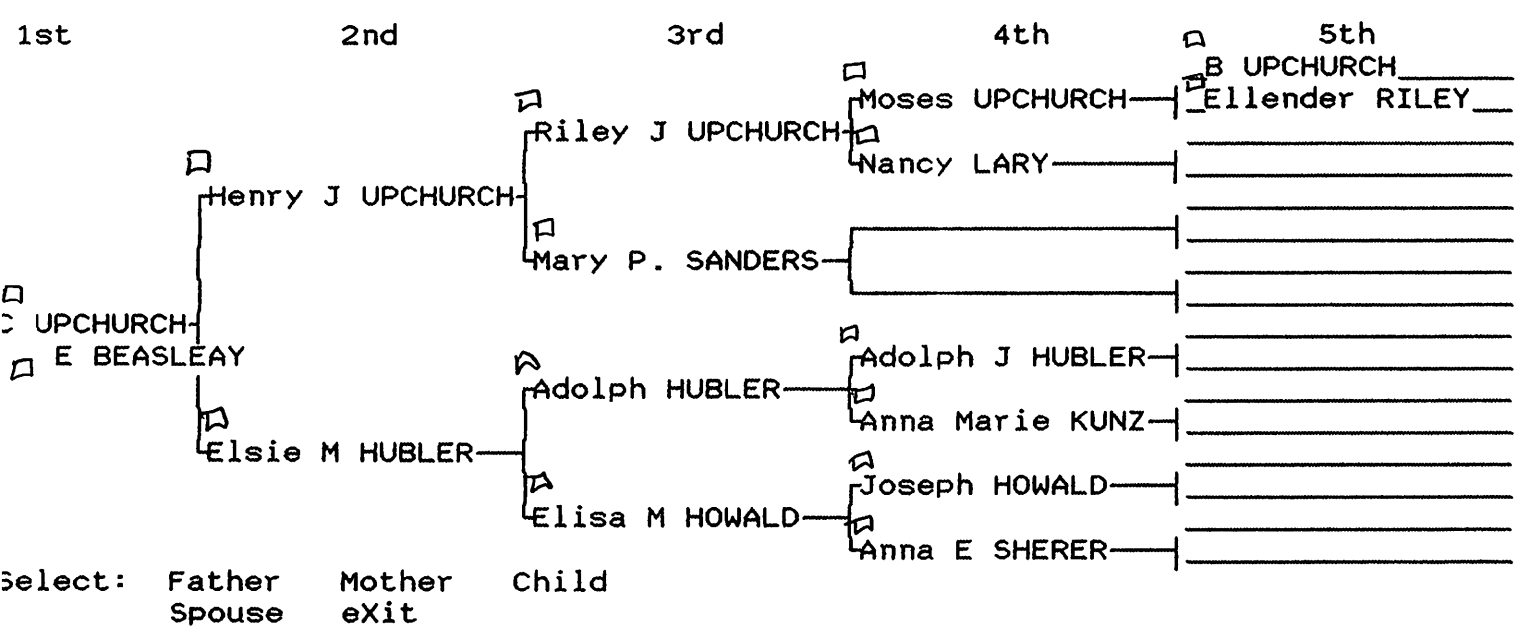

▲ Elizabeth Thyra BEASLEAY-216  
 B: 29 Aug 1939  
 M: (div) --68  
 D:

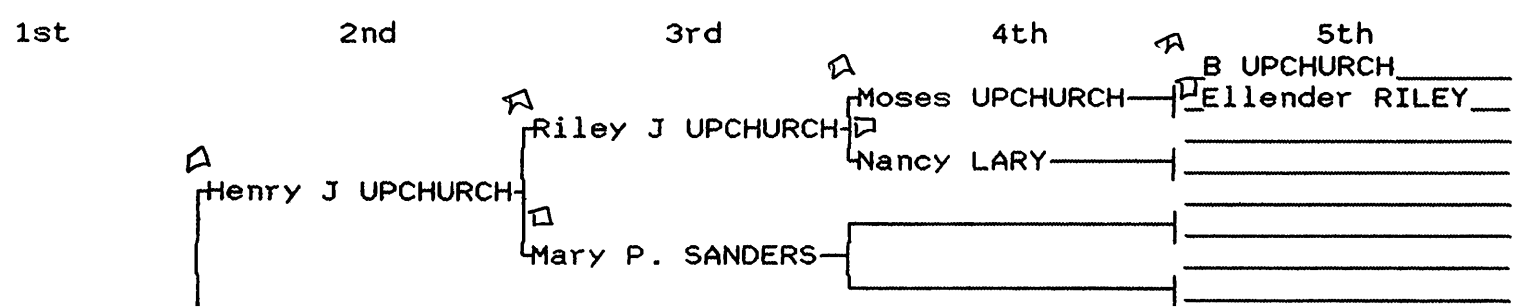



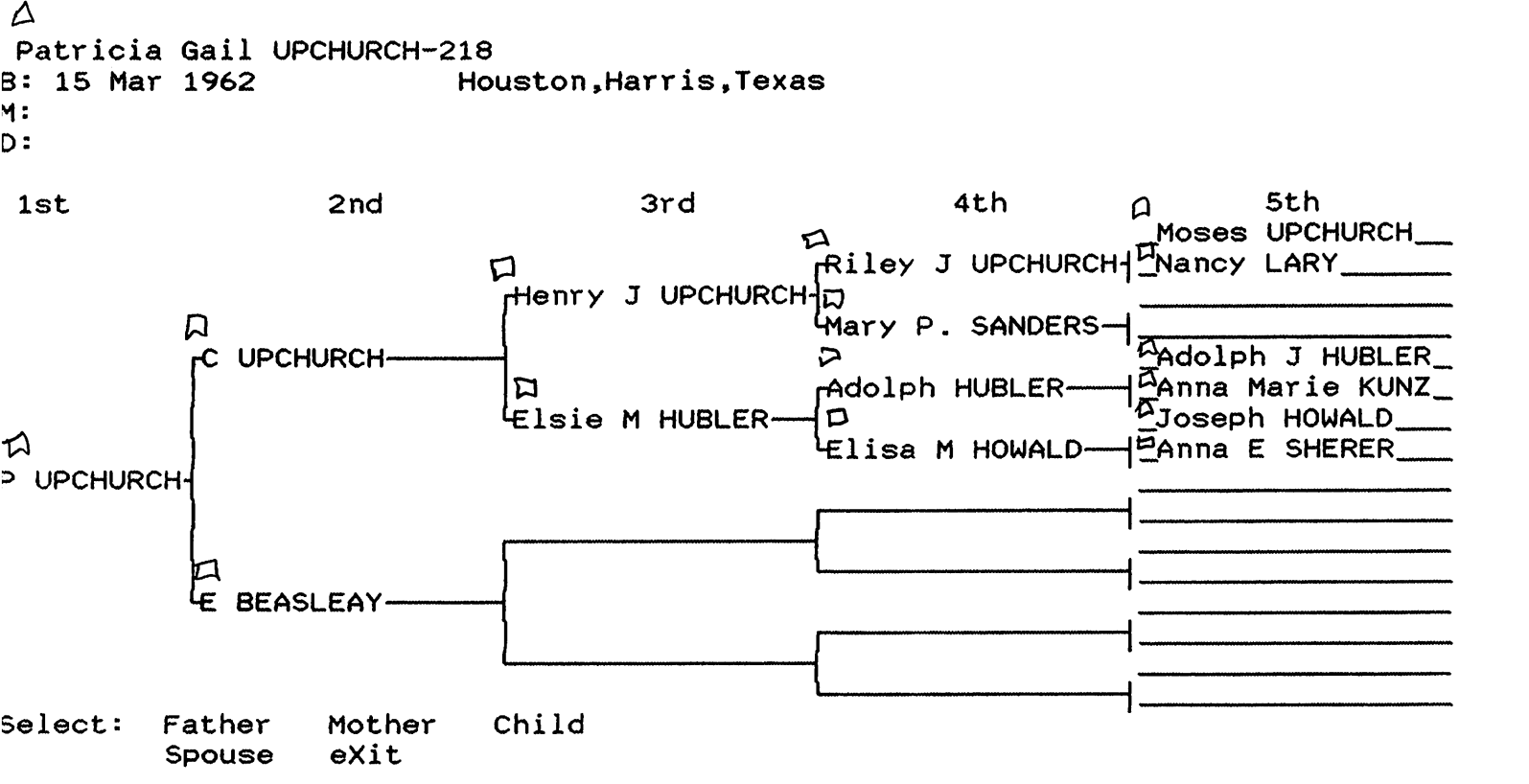
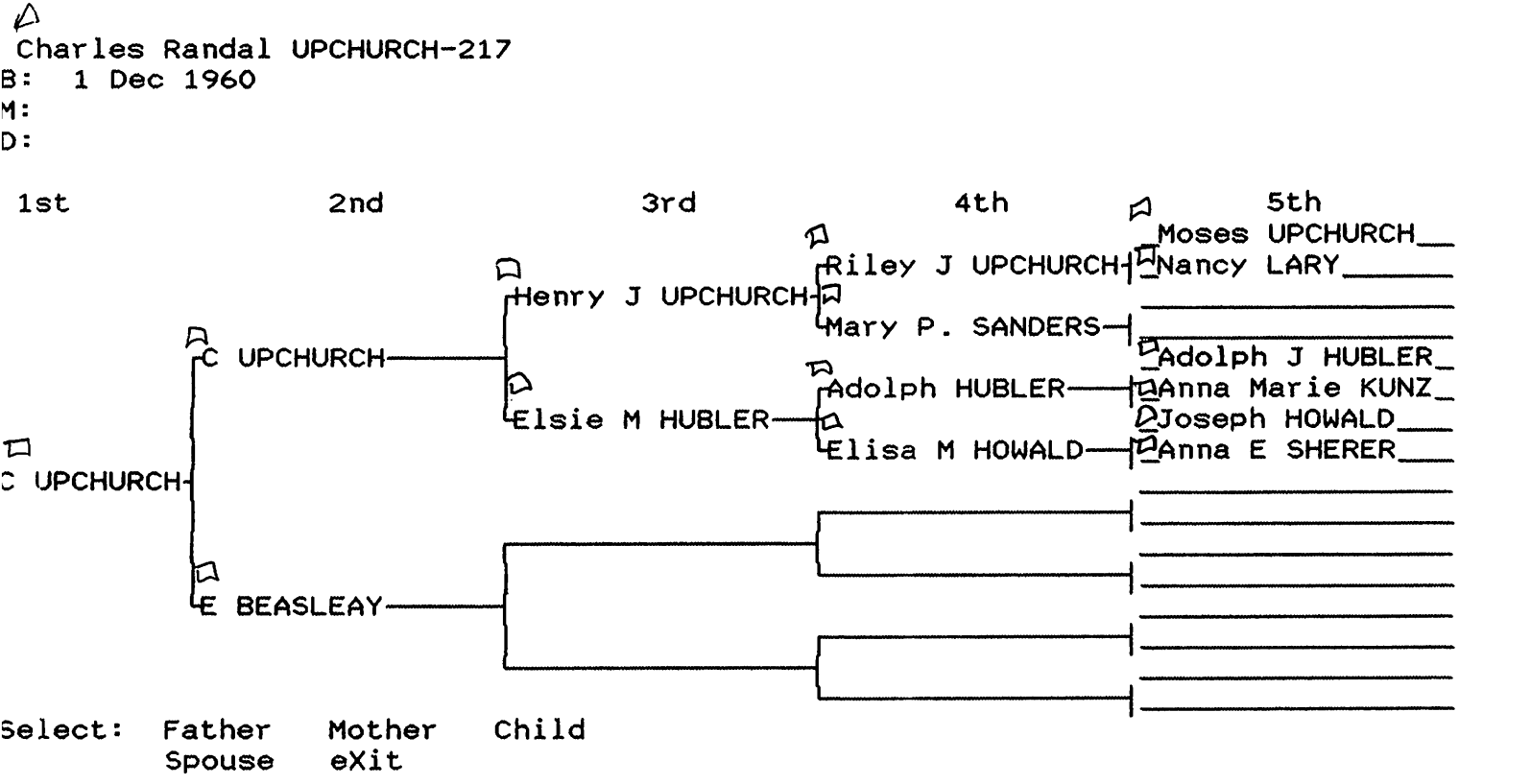
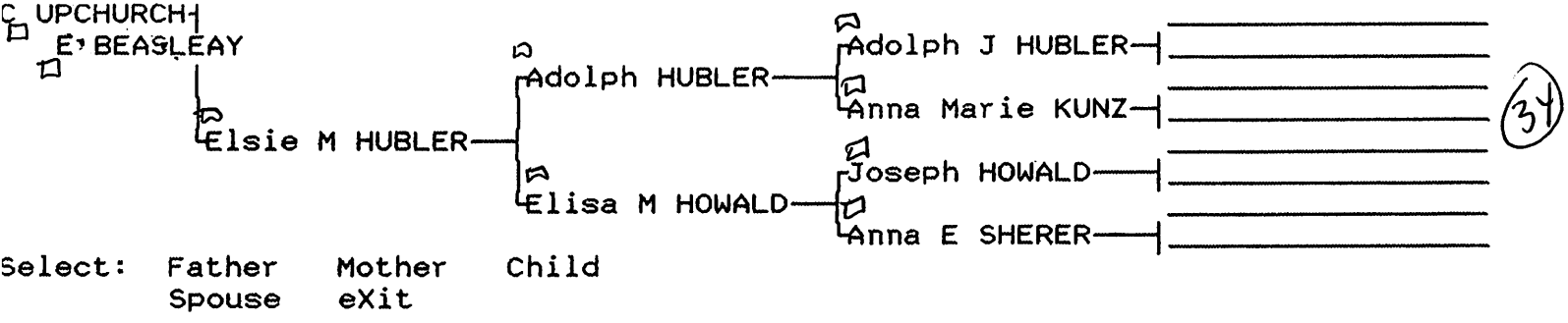

Louise (Luten) BRASHER-219  
B: 31 Jan 1931

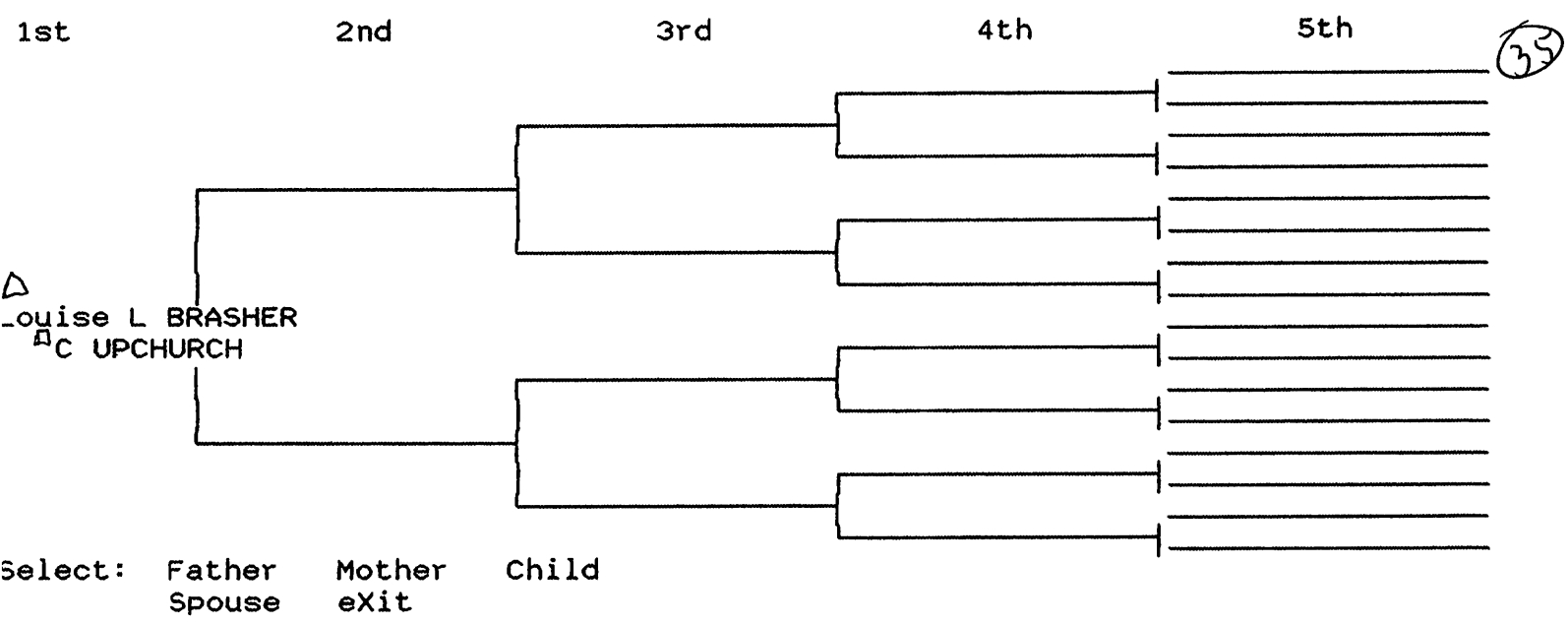

BETTY MARGARET HALL

REC'D  
12 JUL 1992

July 11, 1992

Phil Upchurch,

Betty Battles  
12415 Mullins St.  
Houston, TX 77035

Enclosed are a few answers to questions you asked and some additions you may want.

- |   |   |       |
|---|---|-------|
| □ | I Burwell U. b 1780/90                        | 2029  |
| □ | 3. <sup>21</sup> Cecelia Sarah                | 4954  |
| △ | hus: George W. Howard b: 22 Apr 1837          | 24797 |
| - | (info from tombstone)                         |       |
| △ | a. <u>Castor Howard</u>                       | 4968  |
| △ | MD <u>Estelle D. Freeman</u>                  |       |
| △ | dau: <u>Wilma Howard</u>                      |       |
| - | son: _____                                    |       |
| - |   |       |
| □ | I Burwell U. b 1780/90                        | 2029  |
| □ | C. Moses U. 1816                              | 2030  |
| △ | 4. <sup>21</sup> Riley Judson U.              | 4953  |
| □ | MD (1st) Mary Pina Sanders 1858               | 4969  |
| - | MD (2nd) 1904 <u>Grimes Co. Tx</u>            |       |
| △ | Mary S. b: <u>Grimes Co. Tx</u>               | 5384  |
| - | d: <u>Grimes Co. Tx</u>                       |       |
| △ | a. Elsie Alma U. b: <u>Bedias, Grimes Co.</u> | 5053  |
| - | Tx  |       |
| △ | MD --- ( ) <u>David Daniel Pritchett</u>      | 13345 |
| - | b: --- <u>Grimes Co, Tx</u>                   |       |
| △ | (1) Gertrude Ima U.                           |       |
| - | b: 5 Nov. 1896 Bedias                         |       |
| △ | (Born an albino to Elsie Alma                 |       |
| △ | and her father Riley Judson U.                |       |
| - | Used the name Upchurch                        |       |
| - |   |       |





- I. Burwell U. 2029  
 c. Moses U. 2030  
 b. <sup>2</sup> Milton Ernest U. 4957  
 b: 15 Oct 1860  
 d: 15 Feb 1934
- a. Carvin Ernest U. 5063  
 b. Nettie Virginia U. 5064  
 b:  
 d: 7 Nov 1970
- md: Fritz Hans Hubler 9384  
 b: 27 June 1883  
 d: 26 July 1953
- c.  
 d, Fletcher Garrett U. 5066  
 b: 3 Dec 1889
- e. Walter Jordan U. 7105  
 md Ethel Aline Martin 9390  
 b: 12 Aug 1882  
 Bur: Pankey Cem. Grimes Co, Tx
7. Robert E. Lee U. 4958  
 md (1st) Willie Harrison 4972



□ I Burwell U. 2092

□ c. Moses U. 2030

2. " Oliver Hazard Perry U. 4950

★ I'm sorry I did not understand the following --

mD (1st) Mary A. Senily " 4951

mD (2nd) Mary Hampton " 4952

E Mary mD 1st — 2nd — 3rd — Paulin ]

Explain to Betty

□ 4. Riley Judson 4953

□ a. Elsie Alma 5053

△ b: Loyl Brently U. 5051

b: 24-Jan 1882

△ ~~4.~~ d. John Raymond " Bode" U. 5054

b: Bedias, Grimes Co., Tx

d: Grimes Co., Tx

△ e. Nancy Jane U. 5055

b: Bedias, Grimes Co., Tx

△ mD: Walter Sherwood Brown 13337

b: 7 Jan 1887

Your letter stated that details on the Upchurch Bulletin were enclosed, but I'm afraid they were omitted. I am interested in becoming a subscriber. Please forward that information.

Descendants of Lily Judson are having a reunion in a couple of weeks and hope to have some more data for both of us.

Sincerely,  
Betty Battles